



# HEARNE STEEL CO., INC.

INDUSTRIAL PARK VAUGHN LANE      HEARNE, TEXAS

**Leading Manufacturers Of Chain Link Fence Fittings**

**J.C. AMOS, (1921-2008)**  
**R.W. AMOS, President**  
**CONNIE RICKS, Secretary**  
**C.R. AMOS, CPA-Treasurer**

**OFFICE ADDRESS:**  
**P. O. BOX 1239**  
**HEARNE, TEXAS 77859**  
**PHONE: 979-279-3464**  
**FAX: 979-279-6529**

Thank you for your interest in our products. The attached literature should meet your request. Please feel free to call or visit our website should you need any additional information. Hearne Steel Company is ready to serve you. Reliable service and on-time shipments are just two of the traditions that customers of Hearne Steel Company have come to depend on during the company's 50-year history. Once again, we thank you for your interest in our products, and we look forward to serving your fence hardware needs.

## TERMS AND CONDITIONS:

1. All new customer orders will be shipped upon receipt of either credit card information (Visa/MasterCard/Discover) or a wire transfer (ie. Bank or Western Union) of the order amount until your credit limit is established. Purchases over the credit limit will be held until the limit is either adjusted or outstanding invoices are paid. Our accounting department will notify you when credit is approved and the amount of your credit limit.
2. Terms are Net 30 days from date of shipment, unless otherwise indicated. No payment discount is allowed on freight charges.
3. Customers must contact one of our sales representatives to obtain a prenumbered Return Goods Authorization (RGA) number prior to the return of any products in order to obtain a credit or refund. Goods returned without this authorization and document will not be accepted for credit or refund. A 20% restocking fee will apply to all returned goods. Goods shipped over one year ago will not be acceptable for return. Merchandise must be packaged as originally shipped and tagged with the customer's original purchase order or our invoice number along with the RGA number. Returns must be returned freight prepaid.
4. Shortages, damaged or defective materials must be noted on the bill of lading if delivered by our truck, or on the freight bill, if delivered by common carrier. The notation must be witnessed and signed by the delivering driver. All claims must be filed within 20 days of delivery.
5. All material is available direct from our warehouse in Hearne, Tx., prices are F.O.B. Hearne, Tx.
6. If material certification is required, Hearne Steel Company must be notified at the time the order is placed.



# PRESSED STEEL TABLE OF CONTENTS

<b>BANDS -----</b>	<b>3 – 8</b>
<b>DOMES CAPS &amp; LINE TOPS -----</b>	<b>8 – 10</b>
<b>LINE RAIL CLAMPS, END RAIL CLAMPS, RAIL ENDS &amp; SLEEVES -----</b>	<b>11 – 14</b>
<b>BARB BASES &amp; BARB ARMS -----</b>	<b>15 – 19</b>
<b>HINGES -----</b>	<b>20 – 26</b>
<b>GATE HARDWARE (DOUBLE DRIVE &amp; WALK GATE) -----</b>	<b>27 – 34</b>
<b>COLLARS, FORKS &amp; LATCHES -----</b>	<b>35 – 41</b>
<b>ROLLERS &amp; WHEEL ASSEMBLIES -----</b>	<b>41 – 44</b>
<b>FENCE STRETCHERS, POST DRIVERS &amp; MISCELLANEOUS ----</b>	<b>44 – 49</b>
<b>FLOOR FLANGES &amp; FLOOR PLATES -----</b>	<b>50 – 51</b>



# PRESSED STEEL:

## BANDS:

### TENSION BAND 14 GA. X 3/4"



Tension bands are an offset strip of metal shaped to fit around the terminal post and used with a carriage bolt and nut to attach the tension bar to the post. These bands are made from 14 gauge x 3/4" steel. This gauge band is used in residential and other light duty applications. A 5/16" x 1 1/4" carriage bolt is used. Carriage bolt and nut sold separately.

Part #	Description	Weight	Pc. Per Pkg.
011101	1 3/8" Tension Band 14ga. X 3/4"	0.13	250
011102	1 5/8" Tension Band 14ga. X 3/4"	0.15	250
011103	1 7/8" Tension Band 14ga. X 3/4"	0.16	250
011104	2 3/8" Tension Band 14ga. X 3/4"	0.19	250
011105	2 7/8" Tension Band 14ga. X 3/4"	0.21	200
011106	3 1/2" Tension Band 14ga. X 3/4"	0.25	100
011107	4" Tension Band 14ga. X 3/4"	0.35	100
011108	4 1/2" Tension Band 14ga. X 3/4"	0.35	100
111110	1 3/8" Extra Long Gate Band 14ga. X 3/4"	0.16	250

### TENSION BAND 13 GA. X 7/8"



Tension bands are an offset strip of metal shaped to fit around the terminal post and used with a carriage bolt and nut to attach the tension bar to the post. These bands are made from 13 gauge x 7/8" steel. This gauge band is used in medium duty applications. A 5/16" x 1 1/4" carriage bolt is used. Carriage bolt and nut sold separately.

Part #	Description	Weight	Pc. Per Pkg.
011301	1 3/8" Tension Band 13ga. X 7/8"	0.25	100
011302	1 5/8" Tension Band 13ga. X 7/8"	0.25	100
011303	1 7/8" Tension Band 13ga. X 7/8"	0.27	100
011304	2 3/8" Tension Band 13ga. X 7/8"	0.31	100
011305	2 7/8" Tension Band 13ga. X 7/8"	0.34	100
011306	3 1/2" Tension Band 13ga. X 7/8"	0.38	100
011307	4" Tension Band 13ga. X 7/8"	0.43	100
011308	4 1/2" Tension Band 13ga. X 7/8"	0.50	100
011309	6 5/8" Tension Band 13ga. X 7/8"	0.72	50
011310	8 5/8" Tension Band 13ga. X 7/8"	0.90	50
111322	1 5/8" Extra Long Tension Band 13ga. X 7/8"	0.25	250

## TENSION BAND 11 GA. X 1"



Tension bands are an offset strip of metal shaped to fit around the terminal post and used with a carriage bolt and nut to attach the tension bar to the post. These bands are made from 11 gauge x 1" steel. This gauge band is used in heavy-duty commercial applications. A 3/8" x 1 1/2" carriage bolt is used. Carriage bolt and nut sold separately.

Part #	Description	Weight	Pc. Per Pkg.
011401	1 3/8" Tension Band 11ga. X 1"	0.29	125
011402	1 5/8" Tension Band 11ga. X 1"	0.32	125
011403	1 7/8" Tension Band 11ga. X 1"	0.35	125
011404	2 3/8" Tension Band 11ga. X 1"	0.40	125
011405	2 7/8" Tension Band 11ga. X 1"	0.45	125
011406	3 1/2" Tension Band 11ga. X 1"	0.53	100
011407	4" Tension Band 11ga. X 1"	0.59	100
011408	4 1/2" Tension Band 11ga. X 1"	0.69	50
011409	6 5/8" Tension Band 11ga. X 1"	0.94	50
011410	8 5/8" Tension Band 11ga. X 1"	1.14	50
551436	5 9/16" Tension Band 11ga. X 1"	0.75	50

## SQUARE TENSION BAND 13 GA. X 7/8"

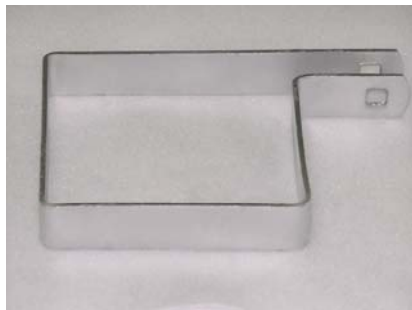

Tension bands are an offset strip of metal shaped to fit around the terminal post and used with a carriage bolt and nut to attach the tension bar to the post. These bands are made from 13 gauge x 7/8" steel. Square bands are used in applications where square posts are used such as ornamental fence. A 5/16" x 1 1/4" carriage bolt is used. Carriage bolt and nut sold separately.

Part #	Description	Weight	Pc. Per Pkg.
011432	1 1/2" Square Tension Band 13ga. X 7/8"	0.20	50
011433	2" Square Tension Band 13ga. X 7/8"	0.28	50
011434	2 1/2" Square Tension Band 13ga. X 7/8"	0.33	50
011435	3" Square Tension Band 13ga. X 7/8"	0.38	50
011437	4" Square Tension Band 13ga. X 7/8"	0.48	25
011439	6" Square Tension Band 13ga. X 7/8"	0.65	25

## BRACE BAND 12 GA. X 3/4"



Brace bands are a symmetrically formed strip of metal shaped to fit around a post and used with a carriage bolt and nut to attach the rail end or brace rail end and truss rod tightener to the post. Also used for attaching barbed wire, tension wire, and other items to a terminal post. These bands are made from 12 gauge x 3/4" steel. This gauge band is used in residential and other light duty applications. A 5/16" x 1 1/4" carriage bolt is used. Carriage bolt and nut sold separately.

Part #	Description	Weight	Pc. Per Pkg.
012201	1 3/8" Brace Band 12ga. X 3/4"	0.15	250
012202	1 5/8" Brace Band 12ga. X 3/4"	0.15	250
012203	1 7/8" Brace Band 12ga. X 3/4"	0.20	250
012204	2 3/8" Brace Band 12ga. X 3/4"	0.22	250
012205	2 7/8" Brace Band 12ga. X 3/4"	0.25	200
012206	3 1/2" Brace Band 12ga. X 3/4"	0.30	100
012207	4" Brace Band 12ga. X 3/4"	0.33	100
012208	4 1/2" Brace Band 12ga. X 3/4"	0.36	100

## BRACE BAND 13 GA. X 7/8"



Brace bands are a symmetrically formed strip of metal shaped to fit around a post and used with a carriage bolt and nut to attach the rail end or brace rail end and truss rod tightener to the post. Also used for attaching barbed wire, tension wire, and other items to a terminal post. These bands are made from 13 gauge x 7/8" steel. This gauge band is used in residential and other light duty applications. A 5/16" x 1 1/4" carriage bolt is used. Carriage bolt and nut sold separately.

Part #	Description	Weight	Pc. Per Pkg.
012301	1 3/8" Brace Band 13ga. X 7/8"	0.18	100
012302	1 5/8" Brace Band 13ga. X 7/8"	0.20	100
012303	1 7/8" Brace Band 13ga. X 7/8"	0.21	100
012304	2 3/8" Brace Band 13ga. X 7/8"	0.26	100
012305	2 7/8" Brace Band 13ga. X 7/8"	0.29	100
012306	3 1/2" Brace Band 13ga. X 7/8"	0.35	100
012307	4" Brace Band 13ga. X 7/8"	0.39	100
012308	4 1/2" Brace Band 13ga. X 7/8"	0.42	100
012309	6 5/8" Brace Band 13ga. X 7/8"	0.73	50
012310	8 5/8" Brace Band 13ga. X 7/8"	0.93	50

## BRACE BAND 11 GA. X 1"

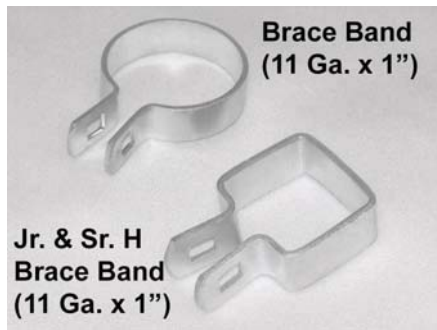

Brace bands are a symmetrically formed strip of metal shaped to fit around a post and used with a carriage bolt and nut to attach the rail end or brace rail end truss and rod tightener to the post. Also used for attaching barbed wire, tension wire, and other items to a terminal post. These bands are made from 11 gauge x 1" steel. This gauge band is used in heavy-duty commercial applications. A 3/8" x 1 1/2" carriage bolt is used. Carriage bolt and nut sold separately.

Part #	Description	Weight	Pc. Per Pkg.
012401	1 3/8" Brace Band 11ga. X 1"	0.24	125
012402	1 5/8" Brace Band 11ga. X 1"	0.28	125
012403	1 7/8" Brace Band 11ga. X 1"	0.29	125
012404	2 3/8" Brace Band 11ga. X 1"	0.36	125
012405	2 7/8" Brace Band 11ga. X 1"	0.41	125
012406	3 1/2" Brace Band 11ga. X 1"	0.55	100
012407	4" Brace Band 11ga. X 1"	0.60	100
012408	4 1/2" Brace Band 11ga. X 1"	0.76	50
012409	6 5/8" Brace Band 11ga. X 1"	0.95	50
012410	8 5/8" Brace Band 11ga. X 1"	1.22	50
012411	JR. H. Brace Band 11ga. X 1"	0.40	125
012412	SR. H. Brace Band 11ga. X 1"	0.46	100
552436	5 9/16" Brace Band 11ga. X 1"	0.70	50

## SQUARE BRACE BAND 13 GA. X 7/8"

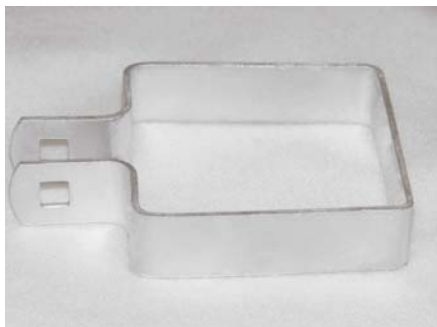

Brace bands are a symmetrically formed strip of metal shaped to fit around a post and used with a carriage bolt and nut to attach the rail end or brace rail end and truss rod tightener to the post. Also used for attaching barbed wire, tension wire, and other items to a terminal post. These bands are made from 13 gauge x 7/8" steel. Square bands are used in applications where square posts are used such as ornamental fence. A 5/16" x 1 1/4" carriage bolt is used. Carriage bolt and nut sold separately.

Part #	Description	Weight	Pc. Per Pkg.
012433	2" Square Brace Band 13ga. X 7/8"	0.30	50
012434	2 1/2" Square Brace Band 13ga. X 7/8"	0.36	50
012435	3" Square Brace Band 13ga. X 7/8"	0.41	50
012437	4" Square Brace Band 13ga. X 7/8"	0.50	25
012439	6" Square Brace Band 13ga. X 7/8"	0.65	25

## TWO-WAY BRACE BAND 12 GA. X 3/4"



Two-way brace bands are a symmetrically formed strip of metal shaped to fit around a post and used with a carriage bolt and nut to attach the two rail ends or two brace rail end and truss rod tighteners to the post. Also used for attaching barbed wire, tension wire, and other items to a terminal post. These bands are made from 12 gauge x 3/4" steel. This gauge band is used in residential and other light duty applications. A 5/16" x 1 1/4" carriage bolt is used. Carriage bolt and nut sold separately. Sometimes called 180° bands.

Part #	Description	Weight	Pr. Per Pkg.
012503	1 7/8" - 2 Way Brace Band 12ga. X 3/4"	0.23	100
012504	2 3/8" - 2 Way Brace Band 12ga. X 3/4"	0.26	100
012505	2 7/8" - 2 Way Brace Band 12ga. X 3/4"	0.30	100
012506	3 1/2" - 2 Way Brace Band 12ga. X 3/4"	0.35	100
012507	4" - 2 Way Brace Band 12ga. X 3/4"	0.40	100

## TWO-WAY BRACE BAND 11 GA. X 1"



Two-way brace bands are a symmetrically formed strip of metal shaped to fit around a post and used with a carriage bolt and nut to attach the two rail ends or two brace rail end and truss rod tighteners to the post. Also used for attaching barbed wire, tension wire, and other items to a terminal post. These bands are made from 11 gauge x 1". This gauge band is used in heavy-duty commercial applications. A 3/8" x 1 1/2" carriage bolt is used. Carriage bolt and nut sold separately. Sometimes called 180° bands.

Part #	Description	Weight	Pr. Per Pkg.
012603	1 7/8" - 2 Way Brace Band 11ga. X 1"	0.35	100
012604	2 3/8" - 2 Way Brace Band 11ga. X 1"	0.42	100
012605	2 7/8" - 2 Way Brace Band 11ga. X 1"	0.45	100
012606	3 1/2" - 2 Way Brace Band 11ga. X 1"	0.50	100
012607	4" - 2 Way Brace Band 11ga. X 1"	0.60	100
012608	4 1/2" - 2 Way Brace Band 11ga. X 1"	0.65	100

## SIGN MOUNTING BRACKET WITH CARRIAGE BOLT



13 gauge x 1" steel strip designed to mount signs to 2 3/8" steel post. This bracket comes with 2 - 5/16" x 1 1/4" carriage bolts and is an inexpensive sign bracket to install commercial signage.

Part #	Description	Weight	Pc. Per Pkg.
885605B	2 3/8" Sign Mounting Bracket with 2 - 5/16" X 1 1/4" Carriage Bolts	0.36	50

## DOMES CAPS & LINE TOPS:

### DOMES CAP



Post caps or dome caps fit atop a post usually to prevent water from corroding inner post and for decorative purposes. (also called post cap)

Part #	Description	Weight	Pc. Per Pkg.
012801	1 3/8" Pressed Steel Dome Cap	0.13	100
012802	1 5/8" Pressed Steel Dome Cap	0.17	100
012803	1 7/8" Pressed Steel Dome Cap	0.23	100
012804	2 3/8" Pressed Steel Dome Cap	0.34	50
012805	2 7/8" Pressed Steel Dome Cap	0.40	50
012807	4" Pressed Steel Dome Cap	0.64	25
012809	6 5/8" Pressed Steel Dome Cap	1.70	10

## WELD ON CAP



Weld on caps are fittings welded atop a post usually to exclude water from tubular posts.

Part #	Description	Weight	Pc. Per Pkg.
012821	1 3/8" Pressed Steel Weld On Cap	0.04	200
012822	1 5/8" Pressed Steel Weld On Cap	0.05	200
012823	1 7/8" Pressed Steel Weld On Cap	0.07	200
012824	2 3/8" Pressed Steel Weld On Cap	0.13	100
012825	2 7/8" Pressed Steel Weld On Cap	0.18	100
012827	4" Pressed Steel Weld On Cap	0.32	50

## UNIVERSAL POST PLATE

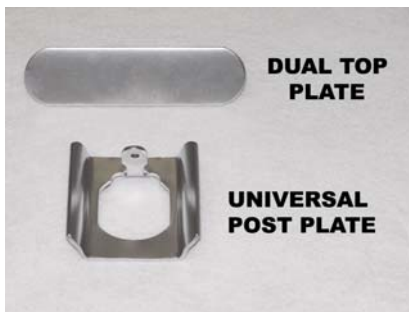

**Dual Top Plate** is used to cover the top of the post.

**Universal Post Plate** bracket is used to attach two post together, which allows horizontal rail to run through the center of your posts.

Part #	Description	Weight	Pc. Per Pkg.
012840	Universal Post Plate	0.33	100
012841	Dual Top Plate	0.34	100

## ECONOMY LINE TOP



Line tops are a cap or top with a loop used to position the top rail or tension wire on top of line posts (also called line post cap, eye top, loop cap, loop top).

Part #	Description	Weight	Pc. Per Pkg.
012931	1 5/8" X 1 3/8" Economy PS Line Top	0.20	50
012933	1 7/8" X 1 3/8" Economy PS Line Top	0.25	50
012934	1 7/8" X 1 5/8" Economy PS Line Top	0.38	50

## LINE TOP



Line tops are a cap or top with a loop used to position the top rail or tension wire on top of line posts (also called line post cap, eye top, loop cap, loop top).

Part #	Description	Weight	Pc. Per Pkg.
013032	1 5/8" X 1 5/8" PS Line Top	0.52	50
013032F	1 5/8" X 1 5/8" Heavy PS Line Top	0.52	50
013033	1 7/8" X 1 5/8" or 1 7/8" PS Line Top	0.56	50
013033F	1 7/8" X 1 5/8" PS Line Top	0.56	50
013034	2 3/8" X 1 5/8" or 1 7/8" PS Line Top	0.75	50
013034F	2 3/8" X 1 5/8" PS Line Top	0.75	50
013035	2 7/8" X 1 5/8" or 1 7/8" PS Line Top	0.75	50
013035F	2 7/8" X 1 5/8" PS Line Top	0.75	25
013036	3 1/2" X 1 5/8" or 1 7/8" PS Line Top	1.45	25
013037	4" X 1 5/8" or 1 7/8" PS Line Top	2.10	25
013038	4 1/2" X 1 5/8" or 1 7/8" PS Line Top	1.65	25

## C-POST LINE TOP



Line top made to fit C-post used to position top rails. Available in standard and heavy sizes.

Part #	Description	Weight	Pc. Per Pkg.
013051	C - Post Line Top STD.	0.70	50
013053	C - Post Line Top HVY.	0.70	50

# LINE RAIL CLAMPS, END RAIL CLAMPS, RAIL ENDS & SLEEVES:

## RAIL END



**Offset rail ends** are a cup-shaped fitting used with a brace band, carriage bolt and nut to connect the top rail or brace to a post. Carriage bolt and nut sold separately. These have 1 hole and the tab is fastened to top of cup at a 45°.

**Combination rail ends** are a cup-shaped fitting used with a brace band, carriage bolt and nut to connect the top rail to a post in conjunction with connecting the truss rod. Carriage bolt & nut is sold separately. These have 2 holes for 3/8" truss rods and 45° tab having 1 hole.

**Brace rail ends** are a cup-shaped fitting used with a brace band, carriage bolt and nut to connect the top rail or brace to a post in conjunction with connecting the truss rod. Carriage bolts and nuts sold separately. Tab has 2 holes and is welded to cup parallel to the ground, there are no holes in the cup.

Part #	Description	Weight	Pc. Per Pkg.
013102	1 5/8" PS Offset Rail End	0.31	100
013102F	1 5/8" PS Offset Rail End	0.31	100
013103	1 7/8" PS Offset Rail End	0.33	50
013104	2 3/8" PS Offset Rail End	0.56	50
013132	1 5/8" PS Combination Rail End	0.31	100
013152	1 5/8" PS Brace Rail End	0.45	100
013152F	1 5/8" PS Brace Rail End	0.45	100
013153	1 7/8" PS Brace Rail End	0.50	50
013154	2 3/8" PS Brace Rail End	0.55	50
013155	2 7/8" PS Brace Rail End	0.65	50

## TOP RAIL SLEEVE

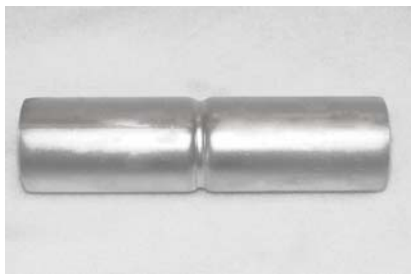

Top rail sleeves are fittings used to join two pieces of top rail when a swedged top rail is not used.

Part #	Description	Weight	Pc. Per Pkg.
013231	1 3/8" X 6" Top Rail Sleeve	0.40	100
013233	1 5/8" X 6" Top Rail Sleeve	0.50	100
013234	1 5/8" X 7" Top Rail Sleeve	0.60	100
013235	1 7/8" X 7" Top Rail Sleeve	0.78	50

## LINE RAIL CLAMP



14 gauge Line Rail Clamps are a two-piece clamp designed for 180° horizontal rail connections to a line post (also called boulevard clamp). 5/16" carriage bolt used. Carriage bolt and nut sold separately.

Part #	Description	Weight	Pr. Per Pkg.
013330	1 3/8" X 1 3/8" Line Rail Clamp	0.54	50
013331	1 5/8" X 1 3/8" Line Rail Clamp	0.54	50
013332	1 5/8" X 1 5/8" Line Rail Clamp	0.73	50
013333	1 7/8" X 1 3/8" Line Rail Clamp	0.72	50
013334	1 7/8" X 1 5/8" Line Rail Clamp	0.75	50
013335	1 7/8" X 1 7/8" Line Rail Clamp	0.74	50
013336	2 3/8" X 1 5/8" Line Rail Clamp	0.75	50
013339	2 7/8" X 1 5/8" Line Rail Clamp	0.85	50
013340	2 7/8" X 1 7/8" Line Rail Clamp	1.20	50
013341	2 7/8" X 2 3/8" Line Rail Clamp	1.24	50
013343	4" X 1 5/8" Line Rail Clamp	0.99	50
0133433	4" X 1 7/8" Line Rail Clamp	1.00	50
013344	4" X 2 3/8" Line Rail Clamp	2.47	25
013345	4" X 2 7/8" Line Rail Clamp	2.76	15

## END RAIL CLAMP



14 gauge End Rail Clamps are a two-piece clamp designed for horizontal rail connections to an end post (also called gate brace clamp). Carriage bolt and nut sold separately.

Part #	Description	Weight	Pr. Per Pkg.
013350	1 3/8" X 1 3/8" End Rail Clamp	0.31	100
013351	1 5/8" X 1 3/8" End Rail Clamp	0.40	50
013352	1 5/8" X 1 5/8" End Rail Clamp	0.56	50
013354	1 7/8" X 1 5/8" End Rail Clamp	0.57	50
013355	1 7/8" X 1 7/8" End Rail Clamp	0.60	50
013356	2 3/8" X 1 5/8" End Rail Clamp	0.61	50
013359	2 7/8" X 1 5/8" End Rail Clamp	0.76	50
013363	4" X 1 5/8" End Rail Clamp	0.90	50

## SQUARE LINE RAIL CLAMP



11 gauge Square Line Rail Clamps are a two-piece clamp designed for 180° horizontal square rail connections to a square line post. Carriage bolt and nut sold separately.

Part #	Description	Weight	Pr. Per Pkg.
013376	2 1/2" X 1 1/4" Square Line Rail Clamp	0.59	50
013377	2 1/2" X 1 1/2" Square Line Rail Clamp	0.70	50

## PANEL CLAMP



Panel clamps are a two-piece clamp designed to secure prefabricated panels on freestanding enclosures. These clamps are made from 8 gauge x 1 1/2" wide steel with approximately 1/2" spacing between the two pieces of tubing. Carriage bolt and nut sold separately.

Part #	Description	Weight	Pr. Per Pkg.
013401	1 3/8" X 1 3/8" PS Panel Clamp	0.50	100
013402	1 5/8" X 1 5/8" PS Panel Clamp	0.63	50
013403	1 7/8" X 1 7/8" PS Panel Clamp	0.75	50
013404	2 3/8" X 2 3/8" PS Panel Clamp	0.96	50
013414	2 3/8" X 1 5/8" PS Panel Clamp	0.82	50
013415	2 7/8" X 1 5/8" PS Panel Clamp	0.97	50

## SADDLE CLAMP



Saddle clamps are a two-piece clamp designed to secure prefabricated panels on freestanding enclosures. These clamps are made from 7 gauge x 1" wide steel with approximately 1 1/4" spacing between the two pieces of tubing. Carriage bolt and nut sold separately.

Part #	Description	Weight	Pr. Per Pkg.
013421	1 3/8" X 1 3/8" PS Saddle Clamp	0.50	100
013422	1 5/8" X 1 5/8" PS Saddle Clamp	0.61	50

## KENNEL CLAMP



Kennel clamps are a two-piece clamp designed to secure prefabricated panels on freestanding enclosures. These clamps are made from 12 gauge x 1 1/2" wide steel with approximately 3/4" spacing between the two pieces of tubing. They are most commonly used for dog kennels and similar applications. Carriage bolt and nut sold separately.

Part #	Description	Weight	Pr. Per Pkg.
013431	1 3/8" X 1 3/8" PS Kennel Clamp	0.50	100

## OFFSET BRACKET

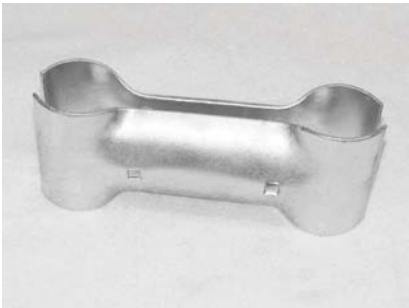

12 gauge Offset Brackets are a two-piece clamp designed to offset a terminal post, approx. 4 7/8" spacing between tubing. Carriage bolt and nut sold separately.

Part #	Description	Weight	Pr. Per Pkg.
013504	2 3/8" X 2 3/8" PS Offset Bracket	2.00	25

## WELDED WIRE CLAMPS



Welded Wire Clamps are designed to attach welded wire panels to the post for support of your panels. Available in 1 5/8", 1 7/8", 2 3/8", 2 7/8" and 4" sizes. Material is 11 gauge x 1.

Part #	Description	Weight	Pr. Per Pkg.
018612	1 5/8" Welded Wire Clamp	0.44	100
018613	1 7/8" Welded Wire Clamp	0.48	100
018614	2 3/8" Welded Wire Clamp	0.53	50
018615	2 7/8" Welded Wire Clamp	0.59	50
018617	4" Welded Wire Clamp	0.73	50

# BARB BASES & BARB ARMS:

## BARB BASE



Barbed wire arm bases are caps or tops used in combination with one or two barbed wire extension arms held in place by a bolt and nut.

Part #	Description	Weight	Pc. Per Pkg.
013602	1 5/8" X 1 5/8" or 1 7/8" PS Barb Base	0.65	50
013603	1 7/8" X 1 5/8" or 1 7/8" PS Barb Base	0.75	50
013604	2 3/8" X 1 5/8" or 1 7/8" PS Barb Base	0.88	50
013605	2 7/8" X 1 5/8" or 1 7/8" PS Barb Base	1.25	50
013607	4" X 1 5/8" or 1 7/8" PS Barb Base	1.70	25

## BARBED WIRE EXTENSION ARMS



**Three wire Z-slot barbed wire extension arms** are made of pressed steel and used in combination with barbed wire base to hold three strands of barbed wire either vertically or angled at 45° in or out from the fence line. These arms are 14" long and 18 gauge.

**V-type barbed wire extension arms** are a pair of three wire Z-slot barbed wire extension arms used in a "V" configuration in combination with barbed wire base to hold 6 strands of barbed wire. These arms are 14" long and 18 gauge.

**Three wire clamp-on barbed wire extension arms** are made of pressed steel and are attached to the post with brace bands. These arms are 18" long and 14 gauge.

Part #	Description	Weight	Pc. Per Pkg.
013631	3 - Wire Z - Slot Extension Arm	0.86	50
013632	3 - Wire V - Type Extension Arm	0.86	50
013633	Clamp On Extension Arm	1.43	25

## HEAVY ONE PIECE PRESSED STEEL 45° ANGLE BARBED WIRE ARM



These are post fittings used to hold barbed wire in place. These arms are angled at 45° and hold three strands of barbed wire. These arms are foreign produced and are not rain-tight.

Part #	Description	Weight	Pc. Per Pkg.
013802	1 5/8" X 1 5/8" Hvy. 1 pc. PS Arm	1.50	25
013803	1 7/8" X 1 5/8" Hvy. 1 pc. PS Arm	1.50	25
013804	2 3/8" X 1 5/8" Hvy. 1 pc. PS Arm	1.63	25

## T-POST ONE PIECE 45° ARM

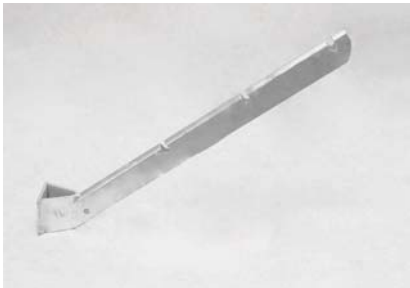

Designed to add height and 3-wire capability to any size T-post 1.01 - 1.50 weight. Can be manufactured to fit on either side of T-post.

Part #	Description	Weight	Pc. Per Pkg.
013810	T - Post 1 pc. Arm	2.30	10

## EXTRA HEAVY ONE PIECE 45° BARB ARM



Designed to hold 3 strands of barb wire in place. These are domestically produced. We can also produce 250 lb. down pull arms. They have the same part number, but with a # sign.

Part #	Description	Weight	Pc. Per Pkg.
013822	1 5/8" X 1 5/8" X - Heavy 1 pc. Arm	1.70	25
013823	1 7/8" X 1 5/8" X - Heavy 1 pc. Arm	1.80	25
013824	2 3/8" X 1 5/8" X - Heavy 1 pc. Arm	2.00	25
013825	2 7/8" X 1 5/8" X - Heavy 1 pc. Arm	2.05	25
013826	3 1/2" X 1 5/8" X - Heavy 1 pc. Arm	2.50	10
013827	4" X 1 5/8" X - Heavy 1 pc. Arm	3.50	10
013828	4 1/2" X 1 5/8" X - Heavy 1 pc. Arm	3.10	10

## EXTRA HEAVY VERTICAL ONE PIECE ARM



Designed to hold 3 strands of barb wire in place. These are 14 1/2" overall measured from top of loop to tip of arm, and are domestically produced.

Part #	Description	Weight	Pc. Per Pkg.
013832	1 5/8" X 1 5/8" X - Heavy Vertical 1 pc. Arm	1.57	25
013833	1 7/8" X 1 5/8" X - Heavy Vertical 1 pc. Arm	1.63	25
013834	2 3/8" X 1 5/8" X - Heavy Vertical 1 pc. Arm	1.82	25
013835	2 7/8" X 1 5/8" X - Heavy Vertical 1 pc. Arm	1.92	25
013836	3 1/2" X 1 5/8" X - Heavy Vertical 1 pc. Arm	2.40	10
013837	4" X 1 5/8" X - Heavy Vertical 1 pc. Arm	3.50	10
013838	4 1/2" X 1 5/8" X - Heavy Vertical 1 pc. Arm	3.00	10

## EXTRA HEAVY V-TYPE ONE PIECE ARM

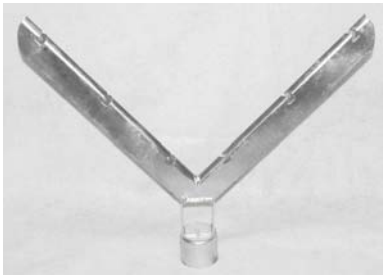

Designed to hold 6 strands of barbwire in place. These are domestically produced. We can also produce 250 lb. down pull arms. They have the same part number, but with a # sign.

Part #	Description	Weight	Pc. Per Pkg.
013842	1 5/8" X 1 5/8" X - Heavy V - Type 1 pc. Arm	2.89	15
013843	1 7/8" X 1 5/8" X - Heavy V - Type 1 pc. Arm	2.95	15
013844	2 3/8" X 1 5/8" X - Heavy V - Type 1 pc. Arm	3.35	15
013845	2 7/8" X 1 5/8" X - Heavy V - Type 1 pc. Arm	3.40	15
013846	3 1/2" X 1 5/8" X - Heavy V - Type 1 pc. Arm	3.70	10
013847	4" X 1 5/8" X - Heavy V - Type 1 pc. Arm	5.10	10
013848	4 1/2" X 1 5/8" X - Heavy V - Type 1 pc. Arm	4.10	10

## PRESSED STEEL C-POST BARB ARMS



Pressed steel one-piece 45° arm designed to fit C-post, available in standard and heavy sizes.

Part #	Description	Weight	Pc. Per Pkg.
013861	C - Post 45° Barb Arm STD.	2.00	25
013863	C - Post 45° Barb Arm HVY.	2.00	25

## PRESSED STEEL C-POST VERTICAL BARB ARM



Designed for three strands of barbwire, available for standard or heavy C-post.

Part #	Description	Weight	Pc. Per Pkg.
013871	C - Post Vertical Barb Arm STD.	2.00	25
013873	C - Post Vertical Barb Arm HVY.	2.00	25

## PRESSED STEEL C-POST V-TYPE BARB ARM



One piece V-Type arm designed for standard or heavy C-post, designed for six wire installation.

Part #	Description	Weight	Pc. Per Pkg.
013881	C - Post V - Type Barb Arm STD.	3.25	15
013883	C - Post V - Type Barb Arm HVY.	3.25	15

## PRESSED STEEL BARBED WIRE CORNER ARM



Pressed steel barbed wire corner arms are a post fitting used to hold barbed wire in place. These arms are angled at 45° and hold three strands of barbed wire.

Part #	Description	Weight	Pc. Per Pkg.
013904	2 3/8" Pressed Steel Corner Arm	5.20	10
013905	2 7/8" Pressed Steel Corner Arm	5.70	10
013906	3 1/2" Pressed Steel Corner Arm	5.80	5
013907	4" Pressed Steel Corner Arm	6.40	5

## PRESSED STEEL V-TYPE CORNER ARM

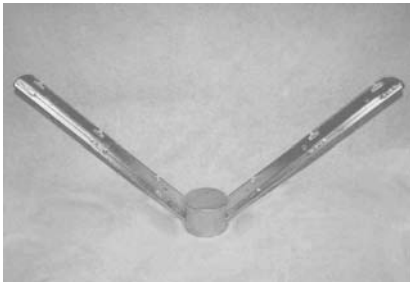

Pressed steel barbed wire V-type corner arms are a post fitting used to hold barbed wire in place. These arms are "V" shaped and hold 6 strands of barbed wire.

Part #	Description	Weight	Pc. Per Pkg.
013924	2 3/8" V - Type PS Corner Arm	8.60	5
013925	2 7/8" V - Type PS Corner Arm	9.30	5
013926	3 1/2" V - Type PS Corner Arm	9.30	5
013927	4" V - Type PS Corner Arm	9.95	5

## UNIVERSAL VERTICAL BARBED WIRE CORNER ARM

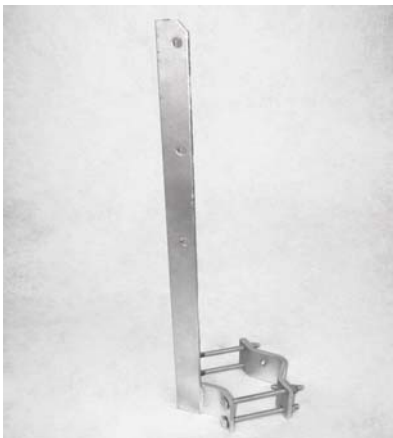

Universal vertical barbed wire corner arms are a post fitting used to hold barbed wire in place. These arms are universal because they fit post sizes 2 1/2" through 4 1/2".

Part #	Description	Weight	Pc. Per Pkg.
013933	Universal Vertical Corner Arm	7.90	5

# **HINGES:**

## **PRESSED STEEL HINGE**



Pressed steel 180° gate hinges are a swing gate hinge that permits the gate to swing 180° from the closed to the open position.

<b>Part #</b>	<b>Description</b>	<b>Weight</b>	<b>Pc. Per Pkg.</b>
014004	2 3/8" X 1 5/8" or 2 PS Hinge	3.50	12
014005	2 7/8" X 1 5/8" or 2 PS Hinge	4.00	12
014006	3 1/2" X 1 5/8" or 2 PS Hinge	4.10	12
014007	4" X 1 5/8" or 2 PS Hinge	4.50	12
014008	4 1/2" X 1 5/8" or 2 PS Hinge	4.50	10
014009	6 5/8" X 1 5/8" or 2 PS Hinge	8.00	4
014010	8 5/8" X 1 5/8" or 2 PS Hinge	11.25	2

## **90° WALL MOUNT HINGE**



Wall mount hinges are a swing gate hinge that permits the gate to swing 90° from the closed to open position. The flat plate is mounted to a wall or flat surface, and can be used on 1 5/8" or 1 7/8" gate frames.

<b>Part #</b>	<b>Description</b>	<b>Weight</b>	<b>Pc. Per Pkg.</b>
014100	90° Wall Mount Hinge	4.00	5

## BULLDOG HINGE



Pressed steel bulldog hinges are a swing gate hinge that permits the gate to swing 90° from the closed to the open position. Bulldog hinges are attached to the post with a 1/2" U-bolt.

Part #	Description	Weight	Pc. Per Pkg.
014104	2 3/8" Bulldog Hinge	2.70	12
014105	2 7/8" Bulldog Hinge	2.80	12
014106	3 1/2" Bulldog Hinge	3.40	12
014107	4" Bulldog Hinge	3.10	12
014108	4 1/2" Bulldog Hinge	3.25	12
014109	6 5/8" Bulldog Hinge	5.70	4
014110	8 5/8" Bulldog Hinge	10.30	2

## BOX HINGE



Pressed steel box hinges are a swing gate hinge that permits the gate to swing 90° from the closed to the open position. Box hinges are attached to the post with a strap and four 3/8" carriage bolts. Carriage bolts and nuts are included.

Part #	Description	Weight	Pc. Per Pkg.
014124	2 3/8" X 1 5/8" or 1 7/8" PS Box Hinge	4.00	12
014125	2 7/8" X 1 5/8" or 1 7/8" PS Box Hinge	4.25	12
014126	3 1/2" X 1 5/8" or 1 7/8" PS Box Hinge	5.10	12
014127	4" X 1 5/8" or 1 7/8" PS Box Hinge	5.00	12
014128	4 1/2" x 1 5/8" or 1 7/8" PS Box Hinge	5.70	12
014129	6 5/8" X 1 5/8" or 1 7/8" PS Box Hinge	8.00	4
014130	8 5/8" X 1 5/8" or 1 7/8" PS Box Hinge	9.00	4

## UNIVERSAL 90° BOX HINGE

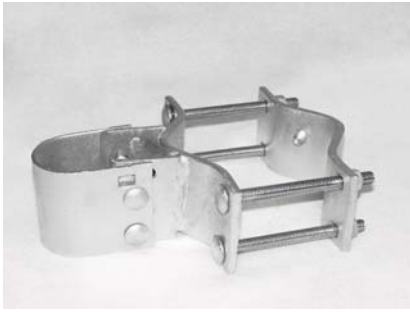

Universal pressed steel box hinges are a swing gate hinge that permits the gate to swing 90° from the closed to the open position. Universal box hinges are attached to the post with a strap and four 3/8" carriage bolts. These hinges are universal because they fit post sizes 2 1/2" through 4 1/2". Bolts and nuts included.

Part #	Description	Weight	Pc. Per Pkg.
014140	Universal 90° Box Hinge (Fits 2 1/2", 3", 3 1/2", 4", 4 1/2")	4.60	12

## GRAVITY HINGE CLOSER



Gravity hinge closers are a swing gate hinge set that is designed to permit the gate to close automatically due to gravity. Carriage bolts and nuts are included.

Part #	Description	Weight	Pc. Per Pkg.
014203	1 3/8" X 1 7/8" Gravity Hinge Closer (w/bolts)	3.00	10
014204	1 3/8" X 2 3/8" Gravity Hinge Closer (w/bolts)	3.00	10

## WELD ON CORRAL HINGE



Designed for corral panels, uses 9" corral pin for attachment. Weld on style. 9 gauge.

Part #	Description	Weight	Pc. Per Pkg.
014224	Weld On Corral Hinge 1 5/8" or 1 7/8"	0.37	100

Hearne Steel Co., Inc  
P.O. Box 1239  
Hearne, TX 77859



Phone: (979) 279-3464  
Fax: (979) 279-6529  
[www.hearnesteel.com](http://www.hearnesteel.com)

## 9" CORRAL PIN



Designed to attach corral panels together for easy assembly.

Part #	Description	Weight	Pc. Per Pkg.
014225	9" Corral Pin	0.65	50

## WELD ON CHAIN LATCH

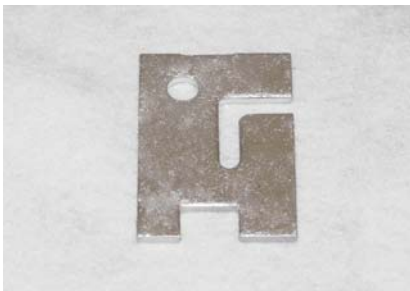

Designed to receive chain on panels for closure.

Part #	Description	Weight	Pc. Per Pkg.
014226	Weld On Chain Latch	0.25	100

## FEMALE GATE HINGE



Female gate hinges are a fitting that attaches to the gate frame and functions with the post hinge (also called frame hinge). A 3/8" carriage bolt is used. Carriage bolt and nut sold separately.

Part #	Description	Weight	Pc. Per Pkg.
014301	1 3/8" X 1/2" – 1" Female Gate Hinge	0.38	100
014302	1 5/8" X 1/2" – 1" Female Gate Hinge	0.58	50
014303	1 7/8" X 1/2" – 1" Female Gate Hinge	0.63	50
014321	1 3/8" X 5/8" – 1" Female Gate Hinge	0.38	100
014322	1 5/8" X 5/8" – 1" Female Gate Hinge	0.58	50
014323	1 7/8" X 5/8" – 1" Female Gate Hinge	0.63	50
014332	1 5/8" X 5/8" – 1 1/4" Female Gate Hinge	0.57	50
014333	1 7/8" X 5/8" - 1 1/4" Female Gate Hinge	0.60	50
014334	2 3/8" X 5/8" - 1 1/4" Female Gate Hinge	0.60	50
014352	1 5/8" X 3/4" - 1 1/2" Female Gate Hinge	0.69	50
014353	1 7/8" X 3/4" - 1 1/2" Female Gate Hinge	0.84	50

## SPLIT KENNEL HINGE



Split kennel hinges are a fitting that one half of the hinge allows the kennel gate frame to swing while the other half attaches to the kennel panel. Two 3/8" x 1 1/2" carriage bolts and nuts are used. Carriage bolts and nuts are sold separately. 8 gauge x 1 1/2" material.

Part #	Description	Weight	Pr. Per Pkg.
014341	1 3/8" Split Kennel Hinge	0.68	50

## WELD ON GATE HINGE



Weld on female 8 gauge steel hinge with 5/8" pinhole, makes a very strong hinge.

Part #	Description	Weight	Pc. Per Pkg.
014362W	1 5/8" X 5/8" - 1 1/2" Weld On Gate Hinge	0.39	50
014363W	1 7/8" X 5/8" - 1 1/2" Weld On Gate Hinge	0.40	50
014373W	1 7/8" X 3/4" - 1 1/2" Weld On Gate Hinge	0.45	50

## SQUARE GATE HINGE



Female gate hinges are a fitting that attaches to the gate frame and functions with the post hinge (also called frame hinge). Square female gate hinges are used in applications where square gate frames are used such as ornamental fence. A 3/8" carriage bolt is used. Carriage bolt and nut sold separately. 8 gauge.

Part #	Description	Weight	Pc. Per Pkg.
014382	1 1/2" X 1/2" - 1" Square Gate Hinge	0.26	50
014391	1" X 5/8" - 1" Square Gate Hinge	0.25	50
014391S	1 1/4" X 5/8" Square Gate Hinge	0.28	50
014392	1 1/2" X 5/8" - 1" Square Gate Hinge	0.30	50
014393	2" X 5/8" - 1" Square Gate Hinge	0.50	50

## REGULAR POST HINGE



Post hinges are a fitting that attaches to the gatepost, the pintle of which fits the frame hinge permitting the gate to swing (also called male hinge). These hinges are made from 8 gauge x 1" wide steel. A 3/8" x 1 1/2" through 3 1/2" carriage bolt is used. Carriage bolt and nut are sold separately.

Part #	Description	Weight	Pc. Per Pkg.
014401	1 3/8" X 5/8" - 1" Reg. Post Hinge	0.55	50
014402	1 5/8" X 5/8" - 1" Reg. Post Hinge	0.60	50
014403	1 7/8" X 5/8" - 1" Reg. Post Hinge	0.65	50
014404	2 3/8" X 5/8" - 1" Reg. Post Hinge	0.70	50
014405	2 7/8" X 5/8" - 1" Reg. Post Hinge	0.85	50

## POST HINGE



Post hinges are a fitting that attaches to the gatepost, the pintle of which fits the frame hinge permitting the gate to swing. These hinges are made from 8 gauge x 1 1/4" wide or 8 gauge x 1 1/2" wide steel. A 3/8" x 2" through 3 1/2" carriage bolt and nut are used. Carriage bolt and nut sold separately.

Part #	Description	Weight	Pc. Per Pkg.
014602	1 5/8" X 1/2" - 1 1/4" Post Hinge	0.75	50
014603	1 7/8" X 1/2" - 1 1/4" Post Hinge	0.75	50
014604	2 3/8" X 1/2" - 1 1/4" Post Hinge	0.90	50
014605	2 7/8" X 1/2" - 1 1/2" Post Hinge	1.02	50
014622	1 5/8" X 5/8" - 1 1/4" Post Hinge	0.75	50
014623	1 7/8" X 5/8" - 1 1/4" Post Hinge	0.76	50
014624	2 3/8" X 5/8" - 1 1/4" Post Hinge	0.85	50
014625	2 7/8" X 5/8" - 1 1/4" Post Hinge	1.00	50
014643	1 7/8" X 5/8" - 1 1/2" Post Hinge	1.06	50
014644	2 3/8" X 5/8" - 1 1/2" Post Hinge	1.06	50
014645	2 7/8" X 5/8" - 1 1/2" Post Hinge	1.20	50

## WELD ON POST HINGE



Weld on male 9 gauge steel hinge with 5/8" pin makes a very strong hinge.

Part #	Description	Weight	Pc. Per Pkg.
014652W	1 5/8" X 5/8" - 1 1/2" Weld-On Post Hinge	0.65	50
014653W	1 7/8" X 5/8" - 1 1/2" Weld-On Post Hinge	0.70	50
014663W	1 7/8" X 3/4" - 1 1/2" Weld-On Post Hinge	0.77	50
014672	5/8" Weld-On Post Hinge	0.83	50

## KENNEL HINGE



Kennel hinges are a fitting that reduces the gap between the gate and panel compared to a male and female hinge combination. A 3/8" x 2" carriage bolt and nut is used. Carriage bolt and nut sold separately. 9 gauge.

Part #	Description	Weight	Pc. Per Pkg.
014671	1 3/8" Kennel Hinge	0.70	50

## SQUARE POST HINGE



Square post hinges are a fitting that attaches to the gate post, the pintle of which fits the frame hinge permitting the gate to swing. A 3/8" x 1 1/2" through 4 1/2" carriage bolt and nut is used. Carriage bolt and nut sold separately. 9 gauge.

Part #	Description	Weight	Pc. Per Pkg.
014681	1" X 5/8" Square Post Hinge	0.40	50
014682	1 1/2" X 5/8" Square Post Hinge	0.50	50
014683	2" X 5/8" Square Post Hinge	0.65	50
014684	2 1/2" X 5/8" Square Post Hinge	0.95	50
014685	3" X 5/8" Square Post Hinge	1.05	25
014687	4" X 5/8" Square Post Hinge	1.30	25

# GATE HARDWARE (DOUBLE DRIVE & WALK GATE):

## AUTOMATIC GATE CLOSER



Automatic gate closers are designed to close gate effortlessly. Steel tube has spring inside to facilitate closing.

Part #	Description	Weight	Pc. Per Pkg.
014703	1 3/8" X 1 7/8" Automatic Gate Closer	3.40	10
014704	1 3/8" X 2 3/8" Automatic Gate Closer	4.00	10
014705	1 3/8" X 2 7/8" Automatic Gate Closer	4.20	10
014723	1 5/8" X 1 7/8" Automatic Gate Closer	3.40	10
014724	1 5/8" X 2 3/8" Automatic Gate Closer	4.21	10
014725	1 5/8" X 2 7/8" Automatic Gate Closer	4.50	10

## WALK GATE SET



Walk gate sets are a package of all necessary parts to install a single walk gate. The components consist of:

- 2 - female gate hinges
- 1 - fork latch assembly
- 2 - male post hinges
- 4 - carriage bolts and nuts

The J-bolt walk gate set comes with 2 - 5/8" x 4 1/2" J-bolts instead of 2 - male post hinges. All the components are packaged in a clear poly bag. These kits are for 1 3/8" gate frames and either 1 7/8" or 2 3/8" male post hinges for gate posts or J-bolts.

Part #	Description	Weight	Pc. Per Pkg.
014803	1 3/8" X 1 7/8" Walk Gate Set	3.50	6
014804	1 3/8" X 2 3/8" Walk Gate Set	3.50	6
014824	2 3/8" J-Bolt Walk Gate Set	3.50	6

## WALK GATE SET WITH DELUXE FORK



Walk gate sets are a package of all necessary parts to install a single walk gate. The components consist of:

- 2 - female gate hinges
- 1 - fork latch assembly
- 2 - male post hinges
- 4 - carriage bolts and nuts

The J-bolt walk gate set comes with 2 - 5/8" x 4 1/2" J-bolts instead of 2 - male post hinges. All the components are packaged in a clear poly bag. These kits are for 1 3/8" gate frames and either 1 7/8" or 2 3/8" male post hinges for gate posts or J-bolts.

Part #	Description	Weight	Pc. Per Pkg.
014833	1 3/8" X 1 7/8" Walk Gate Set w/ Deluxe Fork	3.50	6
014834	1 3/8" X 2 3/8" Walk Gate Set w/ Deluxe Fork	3.50	6
014844	2 3/8" J-Bolt Walk Gate Set w/ Deluxe Fork	3.50	6

## DOUBLE DRIVE GATE SET



Double drive gate sets include a package of all necessary parts to install a double drive gate. The components consist of:

- 4- female gate hinges
- 2- drop rod guides
- 1- fork latch assembly
- 4- male post hinges
- 10- carriage bolts and nuts

The J-bolt double drive gate set comes with 4- 5/8" x 4 1/2" J-bolts instead of 4- male post hinges. All components are packaged in a clear poly bag. These kits are for 1 3/8" gate frames and either 1 7/8" or 2 3/8" male post hinges for gate posts or J-bolts.

Part #	Description	Weight	Pc. Per Pkg.
014903	1 3/8" X 1 7/8" Double Drive Gate Set	6.00	6
014904	1 3/8" X 2 3/8" Double Drive Gate Set	6.00	6
014924	2 3/8" J-Bolt Double Drive Gate Set	6.00	6

## DOUBLE DRIVE GATE SET WITH DELUXE FORK

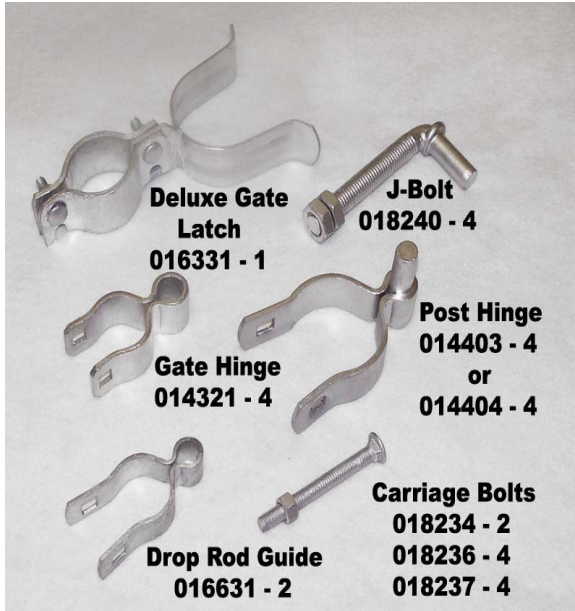

Double drive gate sets include a package of all necessary parts to install a double drive gate. The components consist of:

- 4- female gate hinges
- 2- drop rod guides
- 1- fork latch assembly
- 4- male post hinges
- 10- carriage bolts and nuts

The J-bolt double drive gate set comes with 4- 5/8" x 4 1/2" J-bolts instead of 4- male post hinges. All components are packaged in a clear poly bag. These kits are for 1 3/8" gate frames and either 1 7/8" or 2 3/8" male post hinges for gate posts or J-bolts.

Part #	Description	Weight	Pc. Per Pkg.
014933	1 3/8" X 1 7/8" Dbl. Dr. Gate Set w/ Deluxe Fork	6.00	6
014934	1 3/8" X 2 3/8" Dbl. Dr. Gate Set w/ Deluxe Fork	6.00	6
014944	2 3/8" J-Bolt Dbl. Dr. Gate Set w/ Deluxe Fork	6.00	6

## RESIDENTIAL GATE CORNER BOTTOM AND TOP

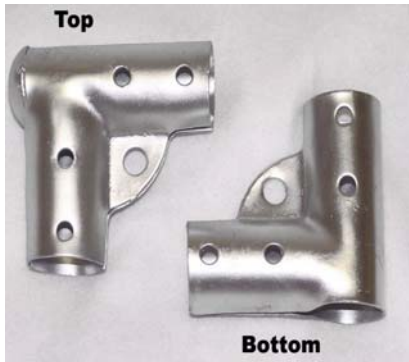

Gate corner bottom and top fittings are used to connect 1 3/8" gate tubing together to form a residential gate.

Part #	Description	Weight	Pc. Per Pkg.
015101	1 3/8" Residential Gate Corner Bottom	0.56	50
015121	1 3/8" Residential Gate Corner Top	0.63	50

## INDUSTRIAL GATE CORNER



Heavier gauge steel (11 gauge) used for commercial gate tubing in 1 5/8" or 1 7/8" sizes in either a one-piece, welded corner or a 2-piece corner not welded together.

Part #	Description	Weight	Pc. Per Pkg.
015202	1 5/8" Industrial Gate Corner	2.50	20
015203	1 7/8" Industrial Gate Corner	2.50	20
015222	1 5/8" - 2 Pc. Industrial Gate Corner	2.50	20
015223	1 7/8" - 2 Pc. Industrial Gate Corner	2.50	20

## GUSSET PLATES

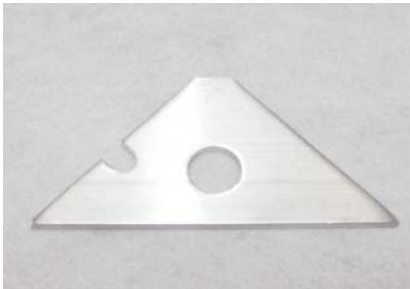

Steel or aluminum gussets are used to weld in the corners of gates for the use of truss rods.

Part #	Description	Weight	Pc. Per Pkg.
777522	3" X 3" X 1/4" Gusset Plate	0.32	50
777522A	3" X 3" X 1/4" Aluminum Gusset Plate	0.15	50

## PRESSED STEEL GATE CLIP



Gate clips are 12 gauge steel fittings used to attach gate fabric to the vertical sides of a gate frame.

Part #	Description	Weight	Pc. Per Pkg.
015331	1 3/8" X 1/2" Regular Gate Clip	0.11	500
015332	1 3/8" X 5/8" Regular Gate Clip	0.13	500
015351	1 3/8" X 1/2" Special Gate Clip	0.11	500
015352	1 3/8" X 5/8" Special Gate Clip	0.13	500
015353	1 3/8" X 3/4" Special Gate Clip	0.15	250
015354	1 5/8" X 3/4" Regular Gate Clip	0.16	250
015355	1 5/8" X 3/4" Special Gate Clip	0.16	250

## TRUSS ROD TIGHTENER

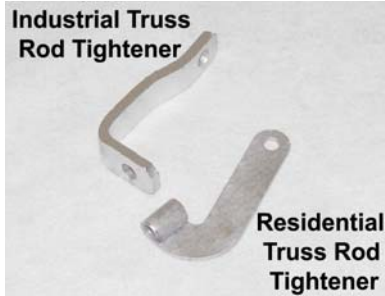

Truss rod tighteners are used to provide support to gate corner posts by way of truss rods that are attached to the tighteners and posts.

Part #	Description	Weight	Pc. Per Pkg.
015571	Industrial Truss Rod Tightener	0.53	50
015573	Residential Truss Rod Tightener	0.20	100

## PRESSED STEEL GATE SCROLL

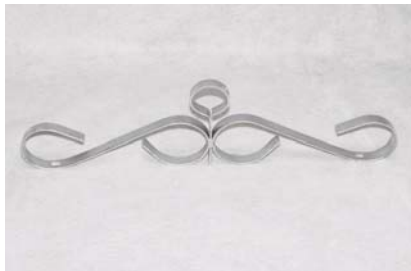

Gate scrolls are decorative fittings attached to gates along the top gate railing.

Part #	Description	Weight	Pc. Per Pkg.
015651	12" Welded Gate Scroll	0.62	10
015653	18" Welded Gate Scroll	1.19	10
015654	24" Welded Gate Scroll	1.32	10
015655	30" Welded Gate Scroll	1.47	10
015656	36" Welded Gate Scroll	1.55	10
015658	48" Welded Gate Scroll	2.05	10

## RESIDENTIAL ROLLING GATE KIT



Double truck wheel assemblies using 6" or 12" carriers and 6" solid rubber tires. Comes with everything to hang rolling gate except bolts, brace bands, and tubing.

### 019031 Rolling Gate Kit #1:

1-#017131-Double Wheel Gate Roller  
6" Wide Carrier with 6" Rubber Tire  
Wheels  
2-#017231 5" Gate Roller and Axle  
2-#017402 1 5/8 Gate Roller Bracket  
2-#017403 1 7/8 Gate Roller Bracket  
6-#017571 Residential Clamp on Holder  
1-#017603 1 5/8 or 1 7/8 Rolling Gate  
Latch

### 019032 Rolling Gate Kit #1 with Universal Clamp on Holder:

1-#017131-Double Wheel Gate Roller  
6" Wide Carrier with 6" Rubber Tire  
Wheels  
2-#017231 5" Gate Roller and Axle  
2-#017402 1 5/8 Gate Roller Bracket  
2-#017403 1 7/8 Gate Roller Bracket  
6-#017573 Universal Clamp on Holder  
1-#017603 1 5/8 or 1 7/8 Rolling Gate  
Latch

### 019033 Rolling Gate Kit #1 with 12" wide Double Wheel Carrier And 6" Solid Rubber Tire Wheels:

1-#017151-Double Wheel Gate Roller  
12" Wide Carrier with 6" Rubber Tire  
Wheels  
2-#017231 5" Gate Roller and Axle  
2-#017402 1 5/8 Gate Roller Bracket  
2-#017403 1 7/8 Gate Roller Bracket  
6-#017571 Residential Clamp on Holder  
1-#017603 1 5/8 or 1 7/8 Rolling Gate  
Latch

Part #	Description	Weight	Pc. Per Pkg.
019031	Rolling Gate Kit #1	21.60	1
019032	Rolling Gate Kit #1 w/ Universal Clamp On Holders	30.15	1
019033	Rolling Gate Kit #1 w/ 12" X 6" Dbl. Wheel Carrier	25.60	1

Hearne Steel Co., Inc  
P.O. Box 1239  
Hearne, TX 77859



Phone: (979) 279-3464  
Fax: (979) 279-6529  
[www.hearnesteel.com](http://www.hearnesteel.com)

# INDUSTRIAL ROLLING GATE KIT



Heavier kit for commercial usage. Double truck is 12" carrier width, and uses 2 U-bolts for strength. Has everything needed to install except bands, bolts, and tubing.

<p><b>019131-Rolling Gate Kit #2:</b>                  1-#017151-Double Wheel Gate Roller                  12" Wide Carrier w/ 6" Rubber Tire Wheels                  2-#017231-5" Gate Roller and Axle                  2-#017402-1 5/8" Gate Roller Bracket                  2-#017403-1 7/8" Gate Roller Bracket                  6-#017573-Universal Clamp on Holder                  1-#017603-1 5/8" or 1 7/8" Rolling Gate Latch</p>	<p><b>019132-Rolling Gate Kit #2 w/ 8" Rubber Tire Wheels:</b>                  1-#017152-Double Wheel Gate Roller                  12" Wide Carrier with 8" Rub. Tire Whls.                  2-#017231-5" Gate Roller And Axle                  2-#017402-1 5/8" Gate Roller Bracket                  2-#017403-1 7/8" Gate Roller Bracket                  6-#017573-Universal Clamp on Holder                  1-#017603-1 5/8" or 1 7/8" Rolling Gate Latch</p>
<p><b>019133-Rolling Gate Kit #2 w/ 10" Rubber Tire Wheel:</b>                  1-#017153-Double Wheel Gate Roller                  12" Wide Carrier w/ 10" Rubber Tire Whls.                  2-#017231-5" Gate Roller and Axle                  2-#017402-1 5/8" Gate Roller Bracket                  2-#017403-1 7/8" Gate Roller Bracket                  6-#017573-Universal Clamp on Holder                  1-#017603-1 5/8" or 1 7/8" Rolling Gate Latch</p>	<p><b>019134-Rolling Gate Kit #2 w/ 7" Rear Wheels:</b>                  1-#017151-Double Wheel Gate Roller                  12" Wide Carrier w/ 6" Rubber Tire Whls.                  2-#017232-7" Gate Roller and Axle                  2-#017402-1 5/8" Gate Roller Bracket                  2-#017403-1 7/8" Gate Roller Bracket                  6-#017573-Universal Clamp on Holder                  1-#017603-1 5/8" or 1 7/8" Rolling Gate Latch</p>
<p><b>019135-Rolling Gate Kit #2 w/ 7" Rear Wheels &amp; 8" Rubber Tire Wheels:</b>                  1-#017152-Double Wheel Gate Roller 12" Wide Carrier w/8" Rubber Tire Wheels                  2-#017232-7" Gate Roller and Axle                  2-#017402-1 5/8" Gate Roller Bracket                  2-#017403-1 7/8" Gate Roller Bracket                  6-#017573-Universal Clamp on Holder                  1-#017603-1 5/8" or 1 7/8" Rolling Gate Latch</p>	<p><b>019136-Rolling Gate Kit #2 w/ 7" Rear Wheels &amp; 10" Rubber Tire Wheel:</b>                  1-#017153-Double Wheel Gate Roller 12" Wide Carrier w/ 10" Rubber Tire Wheels                  2-#017232-7" Gate Roller and Axle                  2-#017402-1 5/8" Gate Roller Bracket                  2-#017403-1 7/8" Gate Roller Bracket                  6-#017573-Universal Clamp on Holder                  1-#017603-1 5/8" or 1 7/8" Rolling Gate Latch</p>

Part #	Description	Weight	Pc. Per Pkg.
019131	Rolling Gate Kit #2	34.10	1
019132	Rolling Gate Kit #2 w/ 8" Rubber Tire Wheels	38.20	1
019133	Rolling Gate Kit #2 w/ 10" Rubber Tire Wheels	39.25	1
019134	Rolling Gate Kit #2 w/ 7" Rear Wheels	38.75	1
019135	Rolling Gate Kit #2 w/ 7" Rear Whls. & 8" Rub. Tire Whls.	42.90	1
019136	Rolling Gate Kit #2 w/ 7" Rear Whls. & 10" Rubber Tire Whls.	43.90	1



## SAFETY TYPE INDUSTRIAL ROLLING GATE KIT



Heavier kit for commercial usage. Double truck is 12" carrier width, and uses 2 U-bolts for strength. Has everything needed to install except bands, bolts, and tubing.

<p><b>019231-Rolling Gate Kit #3:</b>                  1-#017151-Double Wheel Gate Roller 12" Wide Carrier w/6" Rubber Tire Wheel                  2-#017331-5" Safety-type Gate Roller &amp; Axle                  2-#017402-1 5/8" Gate Roller Bracket                  2-#017403-1 7/8" Gate Roller Bracket                  6-#017574-Safety-type Univ. Clamp on Holder                  1-#017603-1 5/8" or 1 7/8" Rolling Gate Latch</p>	<p><b>019232-Rolling Gate Kit #3 w/ 8" Rubber Tire Wheels:</b>                  1-#017152-Double Wheel Gate Roller 12" Wide Carrier w/8" Rub. Tire Wheel                  2-#017331-5" Safety-type Gate Roller &amp; Axle                  2-#017402-1 5/8" Gate Roller Bracket                  2-#017403-1 7/8" Gate Roller Bracket                  6-#017574-Safety-type Univ. Clamp on Hlder                  1-#017603-1 5/8" or 1 7/8' Rolling Gate Latch</p>
<p><b>019233-Rolling Gate Kit #3 w/ 10" Rubber Tire Wheels:</b>                  1-#017153-Double Wheel Gate Roller 12" Wide Carrier w/6" Rubber Tire Wheel                  2-#017331-7" Safety-type Gate Roller &amp; Axle                  2-#017402-1 5/8" Gate Roller Bracket                  2-#017403-1 7/8" Gate Roller Bracket                  6-#017574-Safety-type Univ. Clamp on Holder                  1-#017603-1 5/8" or 1 7/8" Rolling Gate Latch</p>	<p><b>019235-Rolling Gate Kit #3 w/ 7" Rear Wheels &amp; 8" Rubber Tire Wheels:</b>                  1-#017152-Double Wheel Gate Roller 12" Wide Carrier w/8" Rub. Tire Wheel                  2-#017332-7" Safety-type Gate Roller &amp; Axle                  2-#017402-1 5/8" Gate Roller Bracket                  2-#017403-1 7/8" Gate Roller Bracket                  6-#017574-Safety-type Univ. Clamp on Holder                  1-#017603-1 5/8" or 1 7/8" Rolling Gate Latch</p>
<p><b>019236-Rolling Gate Kit #3 w/ 7" Rear Wheels &amp; 10" Pneumatic Tires:</b>                  1-#017153-Double Wheel Gate Roller 12" Wide Carrier w/ 10" Fully Rubber Tire Wheels                  2-#017332-7" Safety-type Gate Roller &amp; Axle                  2-#017402-1 5/8" Gate Roller Bracket                  2-#017403-1 7/8" Gate Roller Bracket                  6-#017574-Safety-type Univ. Clamp on Holder                  1-#017603-1 5/8" or 1 7/8" Rolling Gate Latch</p>	<p><b>019237-Rolling Gate Kit #3 w/ 6" Wide Dbl. Wheel Carrier &amp; 6" Rubber Tire Wheels:</b>                  1-#017131-Double Wheel Gate Roller 6" Wide Carrier w/ 6" Rub. Tire Wheels                  2-#017331-5" Safety-type Gate Roller &amp; Axle                  2-#017402-1 5/8" Gate Roller Bracket                  2-#017403-1 7/8" Gate Roller Bracket                  6-#017574-Safety-type Univ. Clamp on Hlder                  1-#017603-1 5/8" or 1 7/8" Rolling Gate Latch</p>

Part #	Description	Weight	Pc. Per Pkg.
019231	Rolling Gate Kit #3	35.80	1
019232	Rolling Gate Kit #3 w/ 8" Rubber Tire Wheels	39.90	1
019233	Rolling Gate Kit #3 w/ 10" Rubber Tire Wheels	41.05	1
019234	Rolling Gate Kit #3 w/ 7" Rear Wheels	40.60	1
019235	Rolling Gate Kit #3 w/ 7" Rear Whls. & 8" Rub Tire Whls.	44.70	1
019236	Rolling Gate Kit #3 w/ 7" Rear Whls. & 10" Pneu. Tires	45.75	1
019237	Rolling Gate Kit #3 w/ 6" Wide Dbl. Wheel Carrier & 6" Rubber Tire Wheels	27.65	1

# COLLARS, FORKS AND LATCHES:

## PRESSED STEEL COLLAR

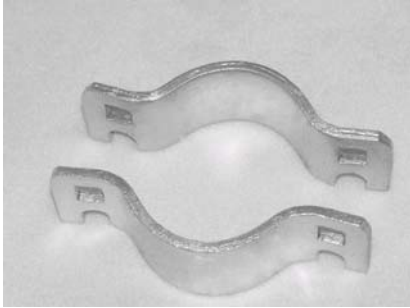

Gate collars are attached to a gate fork and post with carriage bolts to form a gate latch assembly. The collars are made of 8 gauge steel and come in three sizes to fit various post sizes such as:

- 1 3/8"
- 1 5/8"
- 1 7/8"

Part #	Description	Weight	Pr. Per Pkg.
016001	1 3/8" PS Collar	0.43	100
016002	1 5/8" PS Collar	0.50	100
016003	1 7/8" PS Collar	0.56	100

## SQUARE PRESSED STEEL COLLAR

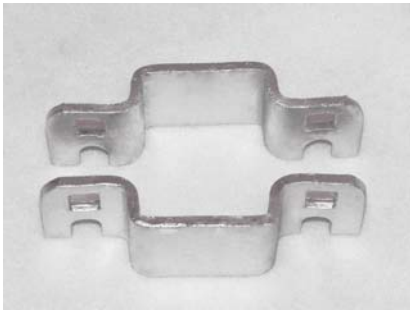

Square gate collars are used with square tubing in ornamental fencing to attach to a gate fork and square post with carriage bolts to form a gate latch assembly. The collars are made with 8 gauge steel and come in four sizes:

- 1"
- 1 1/4"
- 1 1/2"
- 2"

Part #	Description	Weight	Pr. Per Pkg.
016021	1" Square PS Collar	0.35	50
016021S	1 1/4" Square PS Collar	0.43	50
016022	1 1/2" Square PS Collar	0.45	50
016023	2" Square PS Collar	0.60	50

## REGULAR PRESSED STEEL FORK

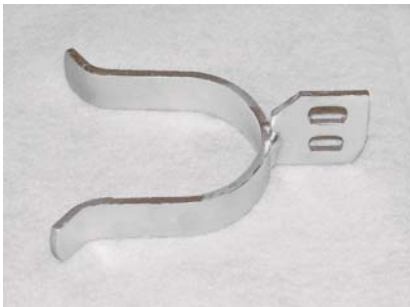

Regular pressed steel forks are 8 gauge x 3/4" fittings that along with gate collars form a fork latch assembly. These forks come in three sizes:

- 1 3/8"
- 1 7/8"
- 2 3/8"

Part #	Description	Weight	Pc. Per Pkg.
016101	1 3/8" PS Fork	0.30	50
016103	1 7/8" PS Fork	0.36	50
016104	2 3/8" PS Fork	0.40	50

## DELUXE PRESSED STEEL FORK



Deluxe pressed steel forks are 1 1/4" wide. These forks come in three sizes:

- 1 3/8"
- 1 7/8"
- 2 3/8"

Part #	Description	Weight	Pc. Per Pkg.
016131	1 3/8" Deluxe PS Fork	0.31	100
016133	1 7/8" Deluxe PS Fork	0.35	100
016134	2 3/8" Deluxe PS Fork	0.44	100

## HEAVY PRESSED STEEL FORK

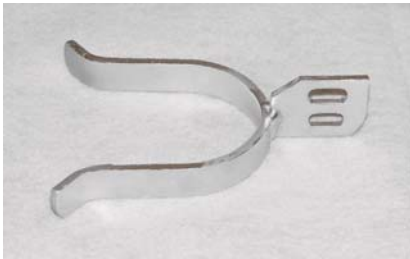

Heavy pressed steel forks are 8 gauge x 1" fittings that along with gate collars form a fork latch assembly. The heavy fork comes in six sizes for post sizes ranging from 1 5/8" to 4". Sizes 3 1/2" and 4" are 8 gauge x 1 1/4"

Part #	Description	Weight	Pc. Per Pkg.
016202	1 5/8" Heavy PS Fork	0.46	100
016203	1 7/8" Heavy PS Fork	0.47	100
016204	2 3/8" Heavy PS Fork	0.50	100
016205	2 7/8" Heavy PS Fork	0.59	25
016206	3 1/2" Heavy PS Fork	0.68	25
016207	4" Heavy PS Fork	0.75	25

## SQUARE PRESSED STEEL FORK



Square gate forks are used to attach to square tubing such as ornamental fencing. The square forks come in six sizes for post sizes ranging from 1" to 4".

Part #	Description	Weight	Pc. Per Pkg.
016221	1" Square PS Fork	0.30	50
016222	1 1/2" Square PS Fork	0.38	50
016223	2" Square PS Fork	0.43	50
016224	2 1/2" Square PS Fork	0.51	50
016225	3" Square PS Fork	0.75	50
016227	4" Square PS Fork	0.95	25

## REGULAR PRESSED STEEL LATCH



A fitting normally used in residential jobs to hold the gate in place when closed. Sizes available are for a 1 3/8" gate post for collar attachment and three sizes for the regular forks to close to:

- 1 3/8"
- 1 7/8"
- 2 3/8"

Part #	Description	Weight	Pc. Per Pkg.
016301	1 3/8" X 1 3/8" Regular PS Latch	0.82	50
016303	1 3/8" X 1 7/8" Regular PS Latch	0.89	50
016304	1 3/8" X 2 3/8" Regular PS Latch	0.90	50

## DELUXE PRESSED STEEL LATCH



Deluxe pressed steel forks are 1 1/4" wide. The forks come in three sizes:

- 1 3/8"
- 1 7/8"
- 2 3/8"

Part #	Description	Weight	Pc. Per Pkg.
016331	1 3/8" X 1 3/8" Deluxe PS Latch	0.84	50
016333	1 3/8" X 1 7/8" Deluxe PS Latch	0.87	50
016334	1 3/8" X 2 3/8" Deluxe PS Latch	0.97	50

## HEAVY PRESSED STEEL LATCH



Heavy pressed steel forks are 8 gauge x 1" fittings that along with gate collars form a fork latch assembly. The heavy fork comes in six sizes for post sizes ranging from 1 7/8" to 3".

Part #	Description	Weight	Pc. Per Pkg.
016403	1 3/8" X 1 7/8" Heavy PS Latch	1.00	50
016404	1 3/8" X 2 3/8" Heavy PS Latch	1.03	50
016405	1 3/8" X 2 7/8" Heavy PS Latch	1.12	50

## INDUSTRIAL SINGLE GATE LATCH

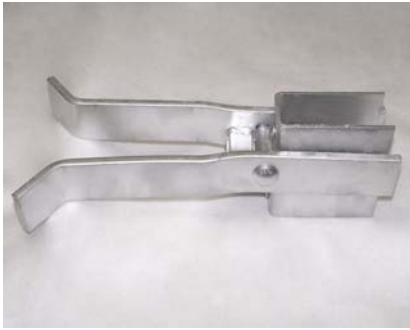

A commercial grade single gate latch with locking capability for enhanced security.

Part #	Description	Weight	Pc. Per Pkg.
016424	1 5/8" or 2" X 2 3/8" or 3" Industrial Single Gate Latch	10.50	2

## PRESSED STEEL BUTTERFLY LATCH



A gate fitting used to hold a gate in place when closed. Used on 1 3/8" gate frame with two fork sizes of 1 7/8" & 2 3/8". Has padlock hole under latch to secure gate.

Part #	Description	Weight	Pc. Per Pkg.
016503	1 3/8" X 1 7/8" Butterfly Latch	1.01	25
016504	1 3/8" X 2 3/8" Butterfly Latch	1.10	25

## KENNEL LATCH



A gate fitting commonly used on dog kennels for 1 3/8" kennel tubing.

Part #	Description	Weight	Pc. Per Pkg.
016521	1 3/8" X 1 3/8" Kennel Latch	0.80	50

## SPRING LATCH



Items sold separately. Can be used to mount on wall, wood post or pipe.

Part #	Description	Weight	Pc. Per Pkg.
016531	Steel Spring Latch	0.60	50
016540	Wall or Wood Post Latch	0.15	100
016544	2 3/8" Clamp-On Post Latch	0.35	100

## RESIDENTIAL DROP ROD ASSEMBLY AND GUIDE



Components that form a double gate latch assembly consisting of a drop rod, and drop rod guide. Items sold separately.

Part #	Description	Weight	Pc. Per Pkg.
016631	1/2" Residential Drop Rod Guide	0.20	250
016641	1/2" X 30" Residential Drop Rod	1.57	25
016671	36" Residential Drop Rod Assembly	2.50	20
016672	44" Residential Drop Rod Assembly	2.80	20

## 24" INDUSTRIAL LOCKABLE DROP ROD



Industrial Drop Rod is made from pipe for a stronger more durable drop rod with a locking tab. Used on round or square industrial gates.

Part #	Description	Weight	Pc. Per Pkg.
016676	24" Industrial Lockable Drop Rod	4.80	5

## INDUSTRIAL DOUBLE GATE LATCH

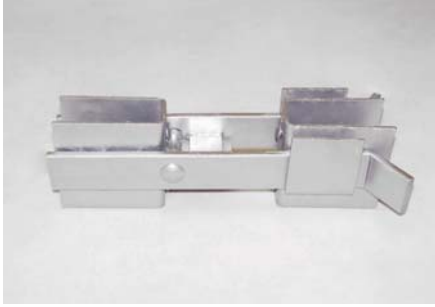

Double Gate Latches have slotted holes to be bolted to 1 5/8" or 1 7/8" gate frames. It eliminates the use of drop rod assembly.

Part #	Description	Weight	Pc. Per Pkg.
016688	1 5/8" or 2" Industrial Double Gate Latch	14.00	2

## INDUSTRIAL GUIDE

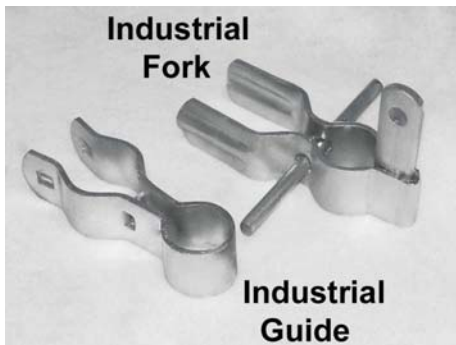

A commercial guide designed for drop rod assemblies. Sizes available are 1 5/8" and 1 7/8".

Part #	Description	Weight	Pc. Per Pkg.
016702	1 5/8" Industrial PS Guide	0.90	50
016703	1 7/8" Industrial PS Guide	0.95	50
016733	1 5/8" or 1 7/8" Industrial PS Fork	1.50	25

## PRESSED STEEL GATE CENTER REST



Steel trough with 12" flat spike for ground anchoring. Designed to accept gate drop rods.

Part #	Description	Weight	Pc. Per Pkg.
016803	2" PS Gate Center Rest	1.30	25

## SINGLE & DOUBLE GATE LATCH

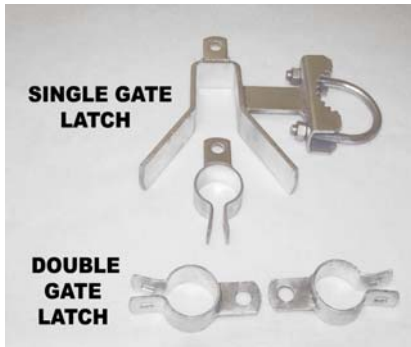

Cantilever latches are used on 2" gate frame and 3", 4", and 6 5/8" terminal post sizes.

Part #	Description	Weight	Pc. Per Pkg.
017003	2" X 2" Double Gate Latch	0.75	10
017005	3" X 2" Single Gate Latch	3.30	10
017007	4" X 2" Single Gate Latch	3.60	10
017009	6 5/8" X 2" Single Gate Latch	6.30	4

## ROLLERS & WHEEL ASSEMBLIES:

### RESIDENTIAL CANTILEVER ROLLER



1 5/8" roller assembly with U-bolt for 2 7/8" tubing. Can also make for 2 3/8" and 4". Designed for light residential use. Uses a pressed steel roller and has sealed bearing assemblies.

Part #	Description	Weight	Pc. Per Pkg.
017071	2 7/8" X 1 5/8" Residential Cantilever Roller	3.25	5

### SINGLE WHEEL GATE ROLLER



Pressed steel single wheel roller assemblies with either 6" or 8" rubber wheels. Available for 1 5/8" or 1 7/8" tubing.

Part #	Description	Weight	Pc. Per Pkg.
017101	1 5/8" Single Whl. Gate Roller w/ 6" Rub. Tire Whl.	4.55	5
017102	1 5/8" Single Whl. Gate Roller w/ 8" Rub. Tire Whl.	6.70	5
017103	1 7/8" Single Whl. Gate Roller w/ 6" Rub. Tire Whl.	4.55	5
017104	1 7/8" Single Whl. Gate Roller w/ 8" Rub. Tire Whl.	6.70	5

## DOUBLE WHEEL GATE ROLLER

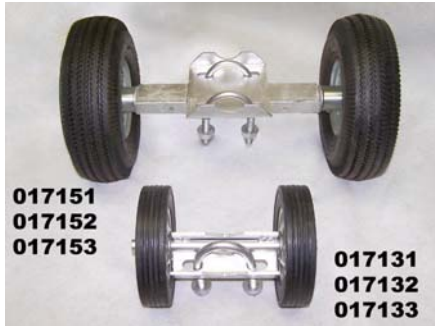

Also known as double front truck roller assemblies. Available with 6", 8" and 10" Rubber Tire Wheels. Also either 6" or 12" wide carriers. Designed to support front of Rolling Gate Assembly. Can also fit 2 3/8" frame, please specify.

Part #	Description	Weight	Pc. Per Pkg.
017131	Dbl. Whl. Gate Roller 6" Wide Carrier w/ 6" Rub. Tire Whl.	6.00	5
017132	Dbl. Whl. Gate Roller 6" Wide Carrier w/ 8" Rub. Tire Whl.	9.45	5
017133	Dbl. Whl. Gate Roller 6" Wide Carrier w/ 10" Rub. Tires Whl.	10.00	2
017151	Dbl. Whl. Gate Roller 12" Wide Carrier w/ 6" Rub. Tire Whl.	10.00	5
017152	Dbl. Whl. Gate Roller 12" Wide Carrier w/ 8" Rub. Tire Whl.	12.85	5
017153	Dbl. Whl. Gate Roller 12" Wide Carrier w/ 10" Rub. Tire Whl.	14.00	2

## GATE ROLLER AND AXLE



Pressed steel 5" or 7" roller assemblies with strap and bolt.

Part #	Description	Weight	Pc. Per Pkg.
017231	5" Gate Roller and Axle	2.40	25
017232	7" Gate Roller and Axle	4.50	10

## SAFETY TYPE GATE ROLLER AND AXLE



1 5/8" wide roller and axle assemblies available in 5" or 7" diameters. They are available in pressed steel and malleable steel. Some are with industrial brackets and some come with out. Malleable wheels come with grease fittings. Safety straps are designed to prevent gate from coming off the track. Also available with 4" black nylon roller for heavy-duty usage with less drag. Axle lengths vary.

Part #	Description	Weight	Pc. Per Pkg.
017331	5" Safety Type Gate Roller & Axle	2.50	25
017332	7" Safety Type Gate Roller & Axle	4.75	10
017333	5" Malleable Sfty. Type Gate Roller & Axle w/ Grease Fit.	5.90	10
017343	5" Mal. Sfty. Type Gate Roller & Axle w/ Ind. Bkt., Complete	7.30	5
017344	5" Safety Type Gate Roller & Axle w/ Ind. Bkt., Complete	4.25	10
017344N	Safety Type Nylon Gate Roller & Axle w/ Ind. Bkt., Complete	3.80	10
017345	7" Safety Type Gate Roller & Axle w/ Ind. Bkt., Complete	6.50	5

## GATE ROLLER BRACKET

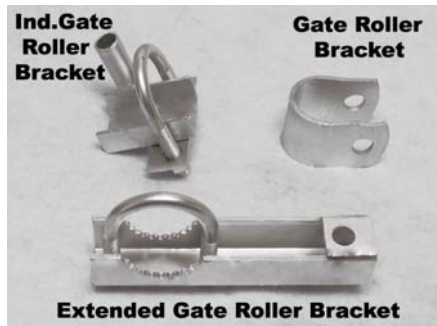

Gate roller brackets are designed to connect the gate roller to the gate for tracking purposes. They are available for 1 3/8", 1 5/8" and 1 7/8" tubing sizes. Also in industrial and extended sizes for special uses. They can be bolted on with U-bolts or single bolts.

Part #	Description	Weight	Pc. Per Pkg.
017401	1 3/8" Gate Roller Bracket	0.63	25
017402	1 5/8" Gate Roller Bracket	0.65	25
017403	1 7/8" Gate Roller Bracket	0.75	25
017433	1 5/8" or 1 7/8" Industrial Gate Roller Bracket	1.60	10
017453	1 5/8" or 1 7/8" Extended Gate Roller Bracket	1.80	25

## CLAMP ON HOLDER



Clamps on with brace bands or u-bolts depending on style. Will fit 2 3/8" or 2 7/8" pipe. Can also fit 2" if specified using smaller U-bolt. Holders designed to clamp rolling gate track tubing onto fence so that fence gate will bypass existing fence. Available in several styles to meet your entire gate hanging needs. Also referred to as gate track brackets.

Part #	Description	Weight	Pc. Per Pkg.
017571	Residential Clamp On Holder	1.00	30
017572	Safety Type Residential Clamp On Holder	1.25	30
017573	Universal Clamp On Holder	2.20	30
017574	Safety Type Universal Clamp On Holder	2.60	20
017575	2" Universal Clamp On Holder	2.05	20
017576	2" Safety Type Universal Clamp On Holder	2.40	20
017578	Flat Back Safety Type Clamp On Holder	2.13	30
017587	4" Safety Type Clamp On Holder Bracket	2.75	10
017588	4 1/2" Safety Type Clamp On Holder Bracket	2.65	10

## ROLLING GATE LATCH



Latch assembly for rolling gates. Can be used on 1 5/8" or 1 7/8" gate frame.

Part #	Description	Weight	Pc. Per Pkg.
017603	1 5/8" or 1 7/8" Rolling Gate Latch	1.85	10

## SWING & SWIVEL GATE ROLLER



Rollers designed to attach to frame of gate either inline or offset. Will work on 1 3/8", 1 5/8", or 1 7/8" tubing. Available with 6" or 8" rubber wheels. Swivel assemblies will work better on irregular surfaces.

Part #	Description	Weight	Pc. Per Pkg.
017833	Swing Gate Roller with 6" Wheel	4.50	5
017834	Swing Gate Roller with 8" Wheel	6.60	5
017854	1 3/8" Swivel Gate Roller with 6" Wheel	4.55	5
017855	1 5/8" Swivel Gate Roller with 6" Wheel	4.80	5
017856	1 7/8" Swivel Gate Roller with 6" Wheel	4.90	5

## FENCE STRETCHERS, POST DRIVERS & MISCELLANEOUS:

### FABRIC TIES & HOG RINGS

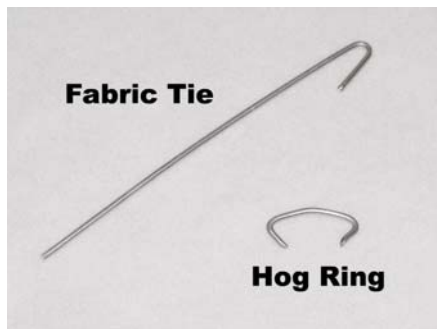

Fabric ties designed to attach chain link to rail tubing. Steel ties are available in 12 gauge with different lengths. Aluminum ties are available in 9 and 11 1/2 gauge with different lengths. Pig rings are 12 gauge steel and come in 10 lb. boxes.

Part #	Description	Wt. Per Bx.	Pc. Per Bx.
018021	Steel Ties 12 ga. X 6 1/2"	28.00	1500
018023	Steel Ties 12 ga. X 8 1/4"	34.00	1500
018031	Aluminum Fabric Ties 11 1/2 ga. X 6 1/2"	42.00	5600
018033	Aluminum Fabric Ties 9 ga. X 6 1/2"	46.00	3700
018034	Aluminum Fabric Ties 9 ga. X 8 1/4"	46.00	3100
018051	12 ga. Steel Pig Rings	10.00	1800

## TENSION BAR



Galvanized steel bars designed to pull fabric tight and to attach to tension bands. Available for 4', 5', and 6 ft. heights.

Part #	Description	Weight	Pc. Per Pkg.
018132	3/16" X 5/8" X 40" Tension Bar	1.36	25
018133	3/16" X 5/8" X 46" Tension Bar	1.56	25
018134	3/16" X 5/8" X 58" Tension Bar	1.96	25
018135	3/16" X 5/8" X 70" Tension Bar	2.36	25
018155	3/16" X 3/4" X 70" Tension Bar	2.90	25

## BOLTS

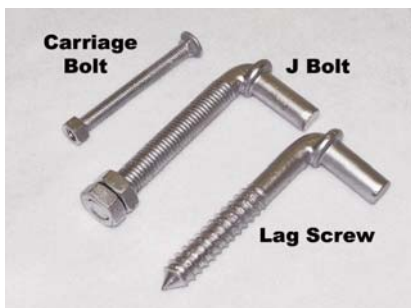

Galvanized bolts used in all areas of fence construction. Also carry lags and J-bolts for hanging gates. Many different sizes of U-bolts also carried.

Part #	Description	Weight	Pc. Per Pkg.
018233	5/16" X 1 1/4" Carriage Bolt	0.05	2000
018234	5/16" X 2" Carriage Bolt	0.08	1000
018235	5/16" X 2 1/2" Carriage Bolt	0.10	1000
018236	3/8" X 2" Carriage Bolt	0.09	1000
018237	3/8" X 2 1/2" Carriage Bolt	0.11	1000
018238	3/8" X 3" Carriage Bolt	0.13	1000
018239	3/8" X 3 1/2" Carriage Bolt	0.14	1000
018240	5/8" X 4 1/2" J-Bolt	0.65	250
018241	5/8" X 4 1/2" Lag Screw	0.50	300

## U-BOLT WITH HEX NUT AND SQUARE U-BOLT WITH HEX NUT

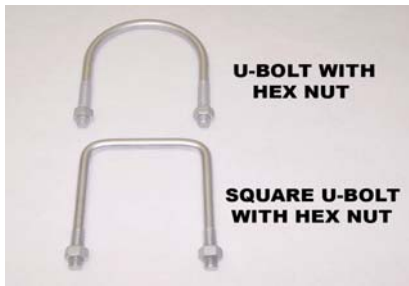

Part #	Description	Weight	Pc. Per Pkg.
018303	1 7/8" X 1/2" U-Bolt with Hex Nut	0.50	50
018304	2 3/8" X 1/2" U-Bolt with Hex Nut	0.61	50
018305	2 7/8" X 1/2" U-Bolt with Hex Nut	0.64	50
018307	4" X 1/2" U-Bolt with Hex Nut	0.81	50
018308	4 1/2" X 1/2" U-Bolt with Hex Nut	0.81	50
018309	6 5/8" X 5/8" U-Bolt with Hex Nut	1.91	25
018323	2" X 1/2" Square U-Bolt with Hex Nut	0.50	50
018327	4 1/2" X 1/2" Square U-Bolt with Hex Nut	.70	50

## FENCE STRETCHER AND PANEL STRETCHER



Stretchers designed for 2 3/8" and 2 7/8" tubing. These units facilitate installation of fabric to terminal post.

Part #	Description	Weight	Pc. Per Pkg.
018404	2 3/8" Fence Stretcher	2.00	10
018405	2 7/8" Fence Stretcher	2.00	10
018424	2 3/8" Heavy Panel Stretcher	6.50	1

## T-POST DRIVER



Drivers designed to install T-posts. Weight is approximately 22 lbs. A must to install posts.

Part #	Description	Weight	Pc. Per Pkg.
018441	T-Post Driver	22.00	1

Hearne Steel Co., Inc  
P.O. Box 1239  
Hearne, TX 77859



Phone: (979) 279-3464  
Fax: (979) 279-6529  
[www.hearnesteel.com](http://www.hearnesteel.com)

## STRETCHER BAR



These bars are designed to pull chain link fabric using a puller or come a-long. They are available in 30", 42", and 68" sizes. Made from heavy gauge galvanized steel.

Part #	Description	Weight	Pc. Per Pkg.
018430	30" Stretcher Bar	9.50	1
018431	36" Stretcher Bar	6.00	5
018433	42" Stretcher Bar	13.00	1
018434	68" Stretcher Bar	20.00	1

## HOG RING PLIER

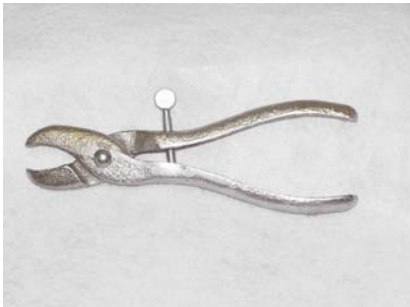

Specialized pliers designed to crush pig rings for easy installation. Made of heavy gauge steel with set screw to prevent over-crushing of rings.

Part #	Description	Weight	Pc. Per Pkg.
018461	Pig Ringer	0.46	10

## GATE CLIP TOOL



Specialized tool used to install special gate clips easily. Made from heavy steel for commercial duty with black rubber grips. Will only work on 1 3/8" or 1 5/8" special gate clips.

Part #	Description	Weight	Pc. Per Pkg.
018471	Gate Clip Tool	4.70	1

## V – GROOVE TRACK



V – Groove Tracks are used with V – Groove Wheels in the tracking of slide gates. It has a 1/4" x 5" strap with 1" x 1" x 1/4" angle welded to it and 9/16" holes every 1'. It comes hot dipped galvanized.

Part #	Description	Weight	Pc. Per Pkg.
018590	10' Steel V – Groove Track	61.00	EACH

## CORRAL LOOP



Used to weld to pipe for running rail, either 1 5/8" or 1 7/8" size. 9 gauge material.

Part #	Description	Weight	Pc. Per Pkg.
018602	1 5/8" Corral Loop	0.32	100
018603	1 7/8" Corral Loop	0.35	100

## PERLIN CLAMP



12 gauge x 3/4" 2 piece strap steel clamp designed to join two pipes at 90° angles. Used mainly in the construction of greenhouses, but can also be used to build portable buildings and for many other uses. Strap steel which is twisted and galvanized, are sold without bolts.

Part #	Description	Weight	Pr. Per Pkg.
018701	1 3/8" X 1 3/8" Perlin Clamp	0.40	100
018702	1 5/8" X 1 3/8" Perlin Clamp	0.40	100
018703	1 7/8" X 1 3/8" Perlin Clamp	0.45	100
018704	2 3/8" X 1 3/8" Perlin Clamp	0.55	50

# FLOOR FLANGES & FLOOR PLATES:

## PRESSED STEEL FLOOR FLANGE

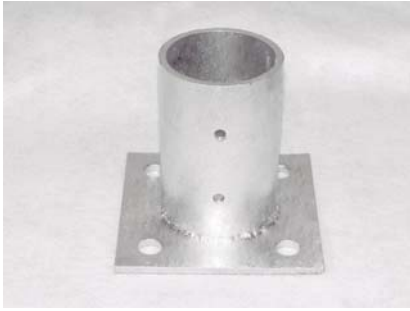

6" x 6" x 1/4" steel flanges with 5/8" holes at each corner. Has 5 1/4" tall flange with 2 set screws to secure tubing. Available for 2", 2 1/2", 3", and 4" tubing. Our galvanized flanges are 1/4" thick. Used for many job start scenarios involving anchoring steel tubing to flat surfaces.

Part #	Description	Weight	Pc. Per Pkg.
018503	1 7/8" PS Floor Flange	4.10	5
018504	2 3/8" PS Floor Flange	5.00	5
018505	2 7/8" PS Floor Flange	6.15	5
018507	4" PS Floor Flange	9.40	5

## ROUND FLOOR FLANGE



Round steel plate for attaching round tubing to flat surfaces.

Part #	Description	Weight	Pc. Per Pkg.
018512	1 5/8" PS Round Floor Flange	.75	50
018513	1 7/8" PS Round Floor Flange	1.00	50
018514	2 3/8" PS Round Floor Flange	1.00	50

## PIPE SUPPORT CLAMP

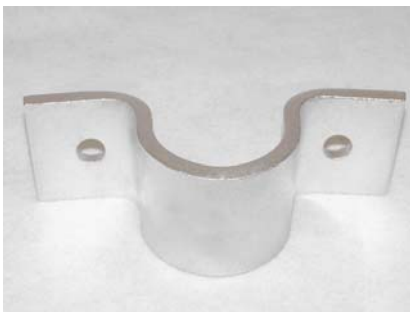

Steel bracket with 3/4" holes to attach a round post to the side of a wall.

Part #	Description	Weight	Pc. Per Pkg.
018524	2 3/8" Pipe Support Clamp	2.55	10
018525	2 7/8" Pipe Support Clamp	2.69	10

## PRESSED STEEL FLOOR PLATE



Steel plates designed for attaching tubing to flat surfaces. Available in many other sizes, call for availability.

Part #	Description	Weight	Pc. Per Pkg.
018530	4" X 4" X 1/4" Floor Plate	1.13	25
018531	3" X 6" X 1/4" Floor Plate	1.28	25
018532	5" X 5" X 1/4" Floor Plate	1.90	25
018533	6" X 6" X 1/4" Floor Plate	2.50	12
018534	8" X 8" X 1/4" Floor Plate	4.50	10
018543	6" X 6" X 3/8" Floor Plate	3.70	8
018544	8" X 8" X 3/8" Floor Plate	6.56	5

## FLOOR PLATE UNCOATED



Steel plates to attach tubing to flat surfaces. These items are uncoated.

Part #	Description	Weight	Pc. Per Pkg.
558528	2" X 4" X 1/4" Floor Plate Uncoated	0.60	50
558530	4" X 4" X 1/8" Floor Plate Uncoated	0.56	50

# WOOD FENCE HARDWARE:

## STRAP HINGE

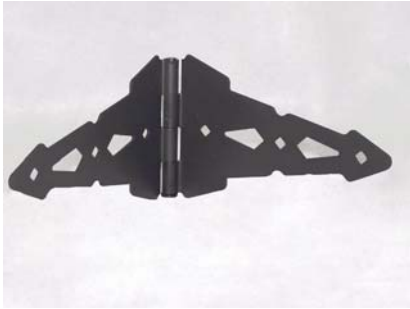

Plastic packed black strap hinges with lag screws.  
Available in 8" or 10" sizes. Screws are powder coated.

\*\* Hinges come (1) PAIR with POWDER COATED LAG SCREWS per plastic bag - 10 bags per box.

Part #	Description	Weight	Pr. Per Pkg.
021101	8" Strap Hinge with Lag Screws	3.25	10
021103	10" Strap Hinge with Lag Screws	4.35	10

## TEE HINGE

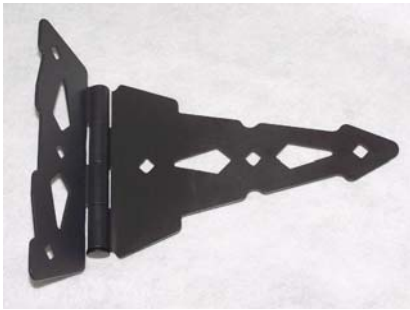

Plastic packed black tee hinges with lag screws.  
Available in 8" or 10" sizes. Screws are powder coated.

\*\* Hinges come (1) PAIR with POWDER COATED LAG SCREWS per plastic bag - 10 bags per box.

Part #	Description	Weight	Pr. Per Pkg.
021201	8" Tee Hinge With Lag Screws	3.10	10
021203	10" Tee Hinge With Lag Screws	3.80	10

## UNIVERSAL WOOD GATE LATCH



Latch assembly kit comes with everything needed to install latch on wood fence.

\*\* Latches include (1) LATCH, (1) HANDLE, (1) STRIKER PIN, and POWDER COATED LAG SCREWS per plastic bag - 12 bags per box.

Part #	Description	Weight	Pc. Per Pkg.
021301	Universal Wood Gate Latch	2.30	12

## CANE BOLT ASSEMBLY

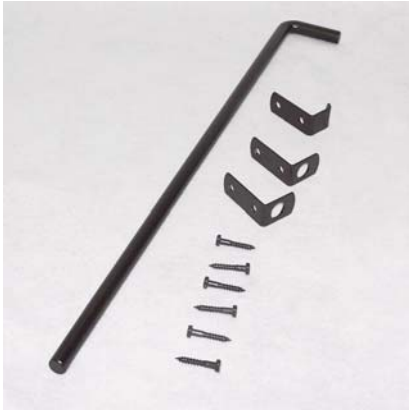

24" bolt assembly designed to secure 1 side of double wood gates. Black Powder Coated to match hinges and latches. Screws included.

Part #	Description	Weight	Pc. Per Pkg.
021433	24" Cane Bolt Assembly (Black Powder Coated)	2.90	10

## WOOD GATE ROLLER



Rollers designed for wood gates. Available for lag screwing to gate rails, in either fixed or swivel configurations. Uses 6" solid rubber tires. Swivel gate roller uses 5" x 5" x 3/16" plate with 4 holes for sturdy mounting.

Part #	Description	Weight	Pc. Per Pkg.
022271	Wood Gate Roller	4.00	5
022272	Swivel Wood Gate Roller With 6" Wheel	5.00	5

## WOOD RAIL SPLICER

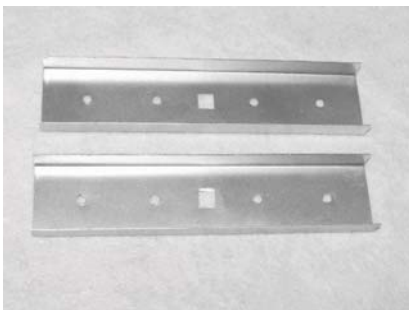

Galvanized steel brackets designed to join 2 wood rails together. Made from 18 gauge steel.

Part #	Description	Weight	Pr. Per Pkg.
022333	1 1/2" X 7" Wood Rail Splicer	.34	100

## LINE WOOD FENCE ADAPTER



14 gauge steel-ell bracket with 9 gauge strap with set screw. Designed to screw onto wood rail and be supported by steel fence post. Very popular item to run wood fencing using steel posts.

Part #	Description	Weight	Pc. Per Pkg.
022402	1 5/8" Line Wood Fence Adapter	0.87	50
022403	1 7/8" Line Wood Fence Adapter	0.90	50
022404	2 3/8" Line Wood Fence Adapter	1.00	50
022405	2 7/8" Line Wood Fence Adapter	1.05	50

## LINE WOOD FENCE ADAPTER WITH SET SCREW



Heavy 3/16" x 2" bracket with 9 gauge strap with set screws. Differs from above due to thicker steel and no lip; so can be mounted anywhere on flat surface.

Part #	Description	Weight	Pc. Per Pkg.
022424	WPA 24 - 2 3/8" Line Wood Adapter w/ Set Screws	1.00	25
022425	WPA 25 - 2 7/8" Line Wood Adapter w/ Set Screws	1.10	25

## LINE WOOD FENCE ADAPTER WITH HINGE STRAP

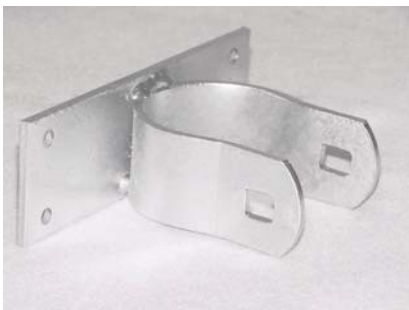

Heavy 3/16" x 2" steel bracket with 9 gauge hinge strap designed to be used with carriage bolt to tighten strap using 3/8" x 3 1/2" bolt (not included).

Part #	Description	Weight	Pc. Per Pkg.
022444	WPA 14 - 2 3/8" Line Wood Adapter w/ Hinge Strap	1.15	25
022445	WPA 15 - 2 7/8" Line Wood Adapter w/ Hinge Strap	1.20	25

## END WOOD FENCE ADAPTER



End of line wood adapter for attaching wood rails to steel posts. Made from 14 gauge steel with 9 gauge strap with set screw. Has 90° lip for wood rail support.

Part #	Description	Weight	Pc. Per Pkg.
022503	1 7/8" End Wood Adapter	0.90	50
022504	2 3/8" End Wood Adapter	1.00	50
022505	2 7/8" End Wood Adapter	1.05	50

## END WOOD FENCE ADAPTER WITH SET SCREW

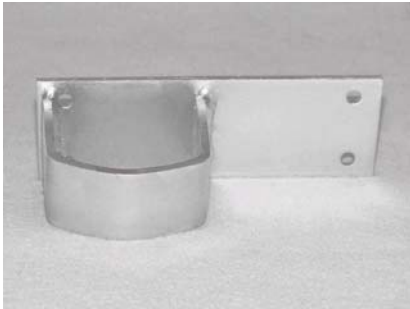

Heavy 3/16" x 2" steel bracket with 9 gauge strap with set screw designed to be used at the end of the line. Used same as above but without a lip so that you can attach it to any flat surface.

Part #	Description	Weight	Pc. Per Pkg.
022524	WPA 34 - 2 3/8" End Wood Adapter w/ Set Screws	1.00	25
022525	WPA 35 - 2 7/8" End Wood Adapter w/ Set Screws	1.10	25

## CORNER WOOD FENCE ADAPTER



90° bracket to attach wood rails to corner steel posts. Bracket is 14 gauge and strap is 9 gauge galvanized metal with set screw. Has 90° lip on adapter for rail to

Part #	Description	Weight	Pc. Per Pkg.
022603	1 7/8" Corner Wood Fence Adapter	1.37	25
022604	2 3/8" Corner Wood Fence Adapter	1.45	25
022605	2 7/8" Corner Wood Fence Adapter	1.50	25

## INSIDE CORNER WOOD FENCE ADAPTER



Bracket designed for inside corner applications. Made of 3/16" x 2" steel with 9 gauge strap with set screw. Does not have lip, so can be mounted on any flat surface.

Part #	Description	Weight	Pc. Per Pkg.
022624	WPA 44 - 2 3/8" Inside Corner Wood Adapt.w/ Set Screw	1.33	25
022625	WPA 45 - 2 7/8" Inside Corner Wood Adapt. w/ Set Screw	1.50	25

## OUTSIDE CORNER WOOD FENCE ADAPTER WITH SET SCREW



Heavy 3/16" x 2" steel bracket with 9 gauge strap with set screw. Similar to inside corner wood fence adapter but to be used for outside installation. Does not have lip, so it can be mounted on any flat surface.

Part #	Description	Weight	Pc. Per Pkg.
022634	WPA 54-2 3/8"Outside Corner Wood Adapt. W/ Set Screw	1.55	25

## DOUBLE WOOD ADAPTER



14 gauge brackets used when double-sided fence is required. Made from 14 gauge steel with 9 gauge strap for pipe attachment with set screw and lip.

Part #	Description	Weight	Pc. Per Pkg.
022643	1 7/8" Double Wood Adapter	1.37	25
022644	2 3/8" Double Wood Adapter	1.50	25
022645	2 7/8" Double Wood Adapter	1.60	25

## ADJUSTABLE LINE WOOD ADAPTER



14 gauge ell bracket with 12 gauge x 3/4" strap for post attachment with lip. Unit is adjustable for gradient variations.

Part #	Description	Weight	Pc. Per Pkg.
022703	1 7/8" Adjustable Line Wood Adapter	0.75	50
022704	2 3/8" Adjustable Line Wood Adapter	0.75	50

## BAND TYPE LINE WOOD ADAPTER



14 gauge galvanized steel ell bracket with 11 gauge band welded to back of bracket.

Part #	Description	Weight	Pc. Per Pkg.
022803	1 7/8" Band Type Line Wood Adapter	0.85	50
022804	2 3/8" Band Type Line Wood Adapter	1.00	50

## ECONOMY BAND TYPE LINE WOOD ADAPTER



Economical 12 gauge x 3/4" band attached to a 14 gauge flat wood adapter plate. Available in several sizes to fit most common posts.

Part #	Description	Weight	Pc. Per Pkg.
022823	1 7/8" Economy Band Type Line Wood Adapter	0.46	50
022824	2 3/8" Economy Band Type Line Wood Adapter	0.49	50
022825	2 7/8" Economy Band Type Line Wood Adapter	0.52	50

## UNIVERSAL WOOD FENCE ADAPTER

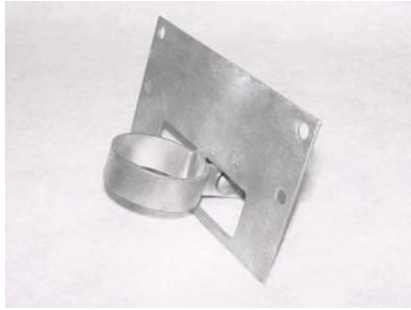

14 gauge flat bracket with holes at all four corners, designed to fit any post from 1 3/8" to 4 1/2" by using proper brace band for attachment. Design features smooth backside of post. Band, bolt and nut sold separately.

Part #	Description	Weight	Pc. Per Pkg.
022900	Universal Wood Adapter	0.40	50

## C-POST LINE WOOD ADAPTER

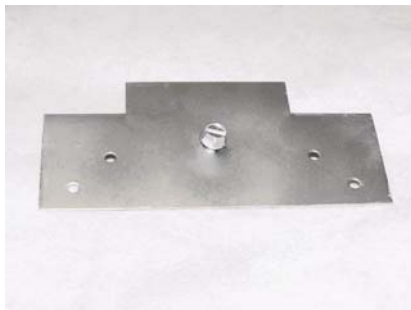

18 gauge pressed steel bracket designed to hold rails for wood fencing on steel C-post.

Part #	Description	Weight	Pc. Per Pkg.
023033	C-Post Line Wood Adapter	0.40	100

## T-POST LINE WOOD ADAPTER



14 gauge pressed steel bracket designed to hold rails when building fence using T-post. Has lip on bottom and set screw digs into "T" on post for secure fastening.

Part #	Description	Weight	Pc. Per Pkg.
023133	T-Post Line Wood Adapter	0.75	50

## 2 X 4 JOINER



18 gauge metal bracket to join rails to wood posts.

Part #	Description	Weight	Pc. Per Pkg.
023333	2" X 4" Joiner	0.16	250

## WALL LATCH BRACKET & WALL LATCH ASSEMBLED

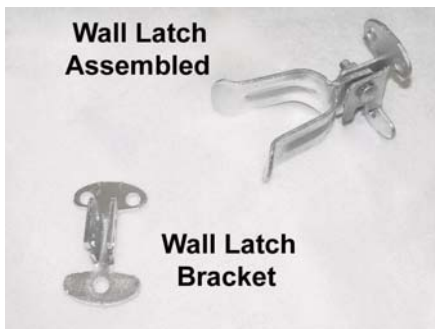

12 gauge flat bracket designed for 1 3/8" fork assemblies. Can be attached to any flat surface with 1/2" lags.

Part #	Description	Weight	Pc. Per Pkg.
023530	Wall Latch Bracket	0.25	50
023531	1 3/8" Wall Latch Assembled	0.60	50

## MALE WOOD POST HINGE & HEAVY MALE WALL PLATE HINGE



Male post hinges made in 8 gauge galvanized steel and have 5/8" pins. Heavy male hinge uses 3" x 5" plate for attachment.

Part #	Description	Weight	Pc. Per Pkg.
023733	Residential Male Wood Post Hinge	0.50	50
023734	Heavy Male Wall Plate Hinge	1.10	10

# MALLEABLE AND SEMI-STEEL FITTINGS:

## SEMI-STEEL DOME CAP



Cast iron or semi-steel post or dome caps available in many sizes.

Part #	Description	Weight	Pc. Per Pkg.
031102	1 5/8" Semi-Steel Dome Cap	0.30	100
031103	1 7/8" Semi-Steel Dome Cap	0.40	100
031104	2 3/8" Semi-Steel Dome Cap	0.71	50
031105	2 7/8" Semi-Steel Dome Cap	0.85	50
031106	3 1/2" Semi-Steel Dome Cap	1.15	25
031107	4" Semi-Steel Dome Cap	1.55	25
031108	4 1/2" Semi-Steel Dome Cap	2.00	25
031109	6 5/8" Semi-Steel Dome Cap	4.89	6
031110	8 5/8" Semi-Steel Dome Cap	9.35	6
031113	5 9/16" Ductile Dome Cap	4.30	10

## SEMI-STEEL LINE TOP



Cast iron line loop caps designed for 1 3/8" and 1 5/8" top rails.

Part #	Description	Weight	Pc. Per Pkg.
031232	1 5/8" X 1 3/8" Semi-Steel Line Top	0.80	50
031234	1 7/8" X 1 3/8" Semi-Steel Line Top	0.85	50
031235	1 7/8" X 1 5/8" Semi-Steel Line Top	0.90	50
031237	2 3/8" X 1 5/8" Semi-Steel Line Top	1.25	25
031239	2 7/8" X 1 5/8" Semi-Steel Line Top	1.70	25

## SEMI-STEEL BARBWIRE BASE, JR. & SR. H BARB BASE



Cast iron bases to mount barb arms to. Available in 1 3/8" and 1 5/8" top rail sizes, and are also available in Jr. & Sr. H sizes.

Part #	Description	Weight	Pc. Per Pkg.
031332	1 5/8" X 1 3/8" Semi-Steel Barbwire Base	1.00	50
031333	1 7/8" X 1 5/8" Semi-Steel Barbwire Base	1.40	50
031334	2 3/8" X 1 5/8" Semi-Steel Barbwire Base	1.70	25
031335	2 7/8" X 1 5/8" Semi-Steel Barbwire Base	2.05	25
031336	Jr. H X 1 5/8" Semi-Steel Barbwire Base	1.60	25
031337	Sr. H X 1 5/8" Semi-Steel Barbwire Base	2.05	25

## SEMI-STEEL BARBWIRE BASE & STEEL ARM, JR. & SR. H BARB BASE & ARM (ASSEMBLED)

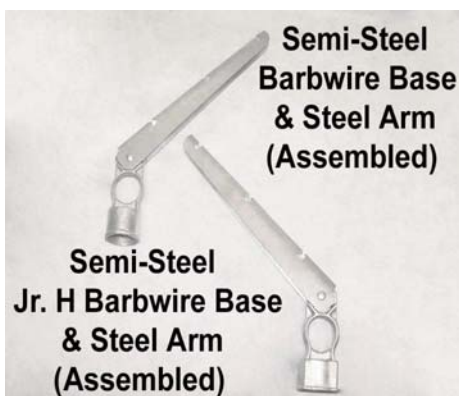

Bases with pressed steel arms installed. Also available for Jr. H and Sr. H. Mostly used with 1 5/8" top rails, but also have for 1 3/8" rails.

Part #	Description	Weight	Pc. Per Pkg.
031432	1 5/8" X 1 3/8" S.S. Base and Steel Arm (Assembled)	1.84	25
031433	1 7/8" X 1 5/8" S.S. Base and Steel Arm (Assembled)	2.55	25
031434	2 3/8" X 1 5/8" S.S. Base and Steel Arm (Assembled)	2.84	25
031435	2 7/8" X 1 5/8" S.S. Base and Steel Arm (Assembled)	3.03	25
031436	Jr. H X 1 5/8" or 1 7/8" X 1 5/8" S.S. Base and Steel Arm (Assembled)	2.79	25
031437	Sr. H X 1 5/8" or 2 3/8" X 1 5/8" S.S. Base and Steel Arm (Assembled)	3.00	25

## SEMI-STEEL OFFSET RAIL END



Rail ends made from cast iron. Available in 3 sizes:  
 1 3/8"  
 1 5/8"  
 1 7/8"

Part #	Description	Weight	Pc. Per Pkg.
031501	1 3/8" Offset Rail End	0.45	100
031502	1 5/8" Offset Rail End	0.60	100
031503	1 7/8" Offset Rail End	0.75	50

## SEMI-STEEL BRACE RAIL END



Available in one or two hole configuration, brace has two holes and the combo has one hole.

Part #	Description	Weight	Pc. Per Pkg.
031602	1 5/8" Brace Rail End	0.70	100
031622	1 5/8" Combination Rail End	0.55	100

## MALLEABLE CORNER ARM



One-piece corner arms designed for 3-wire barb standoffs made from malleable steel.

Part #	Description	Weight	Pc. Per Pkg.
032004	2 3/8" Malleable Corner Arm	2.85	10
032005	2 7/8" Malleable Corner Arm	4.15	10
032007	4" Malleable Corner Arm	5.25	8

## MALLEABLE V-TYPE CORNER ARM



Malleable 6-wire corner arms come with set screw for better stability.

Part #	Description	Weight	Pc. Per Pkg.
032024	2 3/8" Malleable V-Type Corner Arm	5.60	5
032025	2 7/8" Malleable V-Type Corner Arm	6.35	5

## MALLEABLE FLOOR FLANGE



One-piece base with open bottom with four-corner bolt flange. Also has set screws for pipe security.

Part #	Description	Weight	Pc. Per Pkg.
032103	1 7/8" Malleable Floor Flange	4.70	10
032104	2 3/8" Malleable Floor Flange	4.80	8
032105	2 7/8" Malleable Floor Flange	5.10	8

## MALLEABLE BACKSTOP ANGLE



Bracket designed for baseball backstops allowing angled top pipes for containment.

Part #	Description	Weight	Pc. Per Pkg.
032233	3" X 4" X 2" Backstop Angle	3.50	12

## 180° MALLEABLE HINGE INDUSTRIAL



Hinge assembly designed for 1 5/8" or 2" gate tubing; and for 3", 4", or 6 5/8" posts. Comes with U-bolts for easy assembly.

Part #	Description	Weight	Pc. Per Pkg.
032305	3" X 1 5/8" or 2" Malleable 180° Hinge	4.70	12
032307	4" X 1 5/8" or 2" Malleable 180° Hinge	5.50	8
032309	6 5/8" X 1 5/8" or 2" Malleable 180° Hinge	9.90	6

## MALLEABLE AND STEEL HINGE-INDUSTRIAL



90° hinge assembly designed to fit 1 5/8" or 1 7/8" gate frame.

Part #	Description	Weight	Pc. Per Pkg.
032324	2 3/8" Malleable & Steel Hinge	4.00	10
032325	2 7/8" Malleable & Steel Hinge	4.20	10
032326	3 1/2" Malleable & Steel Hinge	4.30	10
032327	4" Malleable & Steel Hinge	4.50	10
032329	6 5/8" Malleable & Steel Hinge	11.55	4
032330	8 5/8" Malleable & Steel Hinge	16.50	4

## 180° ATTACHMENT FOR INDUSTRIAL HINGE



Fitting designed to bolt on pipe for hinge attachment. Very heavy assembly.

Part #	Description	Weight	Pc. Per Pkg.
032433	180° Attachment for Industrial Hinges	4.40	10

## MALLEABLE GATE HOLDBACK

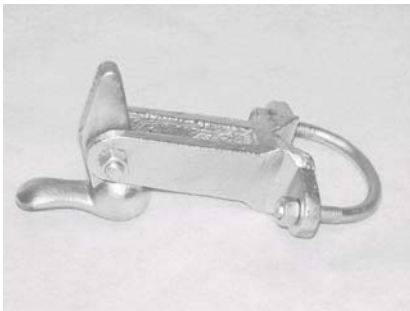

Also commonly known as a duckbill, this unit bolts to pipe to keep gate open.

Part #	Description	Weight	Pc. Per Pkg.
032503	2" Malleable Gate Holdback	2.40	25

## MALLEABLE DROP FORK LATCH



Available in many sizes and attaches with a bent bolt. Very popular clean looking installation.

Part #	Description	Weight	Pc. Per Pkg.
032601	1 3/8" X 1 3/8" Malleable Latch	1.30	25
032603	1 3/8" X 2" Malleable Latch	1.30	25
032604	1 3/8" X 2 1/2" Malleable Latch	1.30	25
032605	1 3/8" X 3" Malleable Latch	1.30	25
032606	1 3/8" X 3 1/2" Malleable Latch	1.82	25
032607	1 3/8" X 4" Malleable Latch	1.85	25
032623	1 5/8" X 2" Malleable Latch	1.40	25
032624	1 5/8" X 2 1/2" Malleable Latch	1.40	25
032625	1 5/8" X 3" Malleable Latch	1.60	25
032626	1 5/8" X 3 1/2" Malleable Latch	1.60	25
032627	1 5/8" X 4" Malleable Latch	1.70	25
032643	1 7/8" X 2" Malleable Latch	1.45	25
032644	1 7/8" X 2 1/2" Malleable Latch	1.50	25
032645	1 7/8" X 3" Malleable Latch	1.50	25
032646	1 7/8" X 3 1/2" Malleable Latch	1.90	25
032647	1 7/8" X 4" Malleable Latch	1.90	25

## MALLEABLE TWO PIECE CORNER & TWO PIECE TEE



Two-piece clamp type corner and tee assemblies designed for easy installation where space may be a factor.

Part #	Description	Weight	Pc. Per Pkg.
032702	1 5/8" Malleable Two Piece Corner	1.90	25
032703	1 7/8" Malleable Two Piece Corner	2.40	25
032722	1 5/8" Malleable Two Piece Tee	1.70	25
032723	1 7/8" Malleable Two Piece Tee	2.40	25

## MALLEABLE GATE CENTER REST



Malleable gate rest.

Part #	Description	Weight	Pc. Per Pkg.
032803	2" Malleable Gate Center Rest	3.20	10

## DELUXE CANTILEVER GATE ROLLER



Malleable hub with malleable steel wheel for 2 1/2" gate, having needle bearings and grease fittings. Has 1 1/8" shaft axle. This unit works very well with automatic openers.

\*Deluxe rollers have needle bearings.

Part #	Description	Weight	Pc. Per Pkg.
033325	3" X 2 1/2" Deluxe* Malleable Cantilever Roller	19.00	2
033327	4" X 2 1/2" Deluxe* Malleable Cantilever Roller	20.00	2
033329	6 5/8" X 2 1/2" Deluxe* Malleable Cantilever Roller	24.00	1
* Deluxe rollers have needle bearings.			

## MALLEABLE & STEEL CANTILEVER GATE ROLLER



Available in sizes that our deluxe unit is not available in. Hub is pressed steel with standard 5/8" U-bolts. Comes with 1 1/8" shaft and grease fitting.

\* Deluxe rollers have needle bearings.

Part #	Description	Weight	Pc. Per Pkg.
033346	3 1/2" X 2 1/2" Deluxe* Mal. & Steel Cantilever Roller	16.10	2
033348	4 1/2" X 2 1/2" Deluxe* Mal. & Steel Cantilever Roller	16.90	2
033350	8 5/8" X 2 1/2" Deluxe* Mal. & Steel Cantilever Roller	28.00	1
* Deluxe rollers have needle bearings.			

## CANTILEVER ROLLER WITH HEAVY DUTY NYLON ROLLER



Top of the line cantilever roller using 1" shaft and graphite nylon rollers. This works very well with high usage gate operator systems. Can also be adapted for square gate frames. Wheels also sold separately.

Part #	Description	Weight	Pc. Per Pkg.
033355	3" X 2 1/2" Cantilever Roller w/ Hvy. Duty Nylon Roller	10.70	2
033357	4" X 2 1/2" Cantilever Roller w/ Hvy. Duty Nylon Roller	12.00	2
033357F	4" X 2 1/2" Cantilever Roller w/ Hvy. Duty Nylon Roller	12.00	2
033359	6 5/8" X 2 1/2" Cant. Roller w/ Hvy. Duty Nylon Roller	16.60	1

## CANTILEVER GATE ROLLER



Malleable hub with 1" axle shaft and grease fitting. These units have self-lubing bronze bushings.

\* These rollers have a self-lubricating, bronze bushing.

Part #	Description	Weight	Pc. Per Pkg.
033334	3" X 2" Malleable Cantilever Roller	18.00	2
033335	3" X 2 1/2" Malleable Cantilever Roller	23.00	2
033336	4" X 2" Malleable Cantilever Roller	20.00	2
033337	4" X 2 1/2" Malleable Cantilever Roller	24.00	2
033339	6 5/8" X 2" Malleable Cantilever Roller	22.00	1
033340	8 5/8" X 2" Malleable Cantilever Roller	26.00	1
These rollers have a self-lubricating, bronze bushing.			

## CANTILEVER ROLLER GUARD



Poly guards designed to fit over cantilever rollers for safety.

Part #	Description	Weight	Pc. Per Pkg.
033500	Cantilever Roller Guard	2.05	2

## V-GROOVE WHEEL



6" x 2" wide wheel designed for double front trucks using embedded angle channel for tracking of gates. Can be purchased installed on double front trucks. Call for availability.

Part #	Description	Weight	Pc. Per Pkg.
033633	6" V-Groove Wheel With 5/8" Axle Bolt	7.30	4

# DIE CAST ALUMINUM FITTINGS:

## ALUMINUM DOME CAP



Cast aluminum caps for sealing pipe to prevent corrosion.

Part #	Description	Weight	Pc. Per Pkg.
041101	1 3/8" Aluminum Dome Cap	0.03	350
041102	1 5/8" Aluminum Dome Cap	0.05	350
041103	1 7/8" Aluminum Dome Cap	0.10	250
041104	2 3/8" Aluminum Dome Cap	0.10	150
041105	2 7/8" Aluminum Dome Cap	0.15	150
041107	4" Aluminum Dome Cap	0.25	50
041109	6 5/8" Aluminum Dome Cap	0.56	25

## ALUMINUM DRIVE-IN PLUG



Plugs designed for drive-in fitting.

Part #	Description	Weight	Pc. Per Pkg.
041301	1 3/8" Aluminum Drive In Plug	0.03	350
041302	1 5/8" Aluminum Drive In Plug	0.05	350
041303	1 7/8" Aluminum Drive In Plug	0.07	350

## ALUMINUM BULLET TOP AND CONCAVE ADAPTER



Plain, one way, and two-way caps designed to finish fence installations. Designed to accept standard top rail where needed. Concave adapters used to attach top rails by bolting on either side of smooth bullet tops to make 1-way or 2-way bullet tops.

Part #	Description	Weight	Pc. Per Pkg.
042232	2 3/8" Plain Bullet Top	0.20	100
042233	2 3/8" 1-Way Bullet Top	0.24	100
042234	2 3/8" 2-Way Bullet Top	0.26	100
042241	1 3/8" Aluminum Concave Adapter	0.10	200

## ALUMINUM LINE TOP



Loop caps designed for either 1 3/8" or 1 5/8" top rails.

Part #	Description	Weight	Pc. Per Pkg.
043332	1 5/8" X 1 3/8" Aluminum Line Top	0.11	200
043334	1 7/8" X 1 3/8" Aluminum Line Top	0.16	100
043335	1 7/8" X 1 5/8" Aluminum Line Top	0.17	100
043337	2 3/8" X 1 5/8" Aluminum Line Top	0.20	100

## ALUMINUM OFFSET RAIL END



Offset rail end brackets designed to stop top rails. To be used with brace bands.

Part #	Description	Weight	Pc. Per Pkg.
046601	1 3/8" Aluminum Offset Rail End	0.13	500
046602	1 5/8" Aluminum Offset Rail End	0.15	250

## ALUMINUM GATE CORNER



Solid corner for a clean corner on gate assemblies. Also available in split design.

Part #	Description	Weight	Pc. Per Pkg.
047733	1 3/8" Solid Aluminum Gate Corner	0.36	100
047734	1 3/8" Split Aluminum Gate Corner	0.44	100

## ALUMINUM GATE CLOSER



Spring loaded closure designed to work in either direction.

Part #	Description	Weight	Pc. Per Pkg.
048803	1 3/8" X 1 7/8" Aluminum Gate Closer	1.00	12
048804	1 3/8" X 2 3/8" Aluminum Gate Closer	1.10	12

# ORNAMENTAL IRON FITTINGS:

## CAST IRON BALL TOP SPEAR



Unfinished cast iron designed to fit on square tubing.

Part #	Description	Weight	Pc. Per Pkg.
050301	1/2" Cast Iron Ball Top Spear	0.25	50
050302	5/8" Cast Iron Ball Top Spear	0.32	50
050303	3/4" Cast Iron Ball Top Spear	0.32	50

## CAST IRON AMERICAN SPEAR TOP



Unfinished cast iron spear top designed for square tubing.

Part #	Description	Weight	Pc. Per Pkg.
050321	1/2" Cast Iron American Spear Top	0.38	50
050322	5/8" Cast Iron American Spear Top	0.35	50
050323	3/4" Cast Iron American Spear Top	0.32	50

## CAST IRON BALL CAP



Unfinished cast iron caps used for square tubing. Available in 2", 3", and 4" sizes.

Part #	Description	Weight	Pc. Per Pkg.
050503	2" Cast Iron Ball Cap	2.32	30
050505	3" Cast Iron Ball Cap	3.00	15
050507	4" Cast Iron Ball Cap	5.05	10

## CAST IRON PLAIN POST CAP



Unfinished cast iron caps designed to fit square tubing in 2", 3", and 4" sizes.

Part #	Description	Weight	Pc. Per Pkg.
050523	2" Cast Iron Plain Post Cap	0.38	50
050525	3" Cast Iron Plain Post Cap	0.94	25
050527	4" Cast Iron Plain Post Cap	1.40	20

## SQUARE TENSION BAND 13 GA X 7/8"

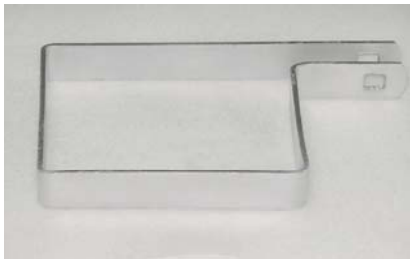

Galvanized bands designed for square tubing. Designed to pull fabric and attach to square tubing. 13 gauge x 7/8" for strength.

Part #	Description	Weight	Pc. Per Pkg.
011432	1 1/2" Square Tension Band 13ga. X 7/8"	0.20	50
011433	2" Square Tension Band 13ga. X 7/8"	0.28	50
011434	2 1/2" Square Tension Band 13ga. X 7/8"	0.33	50
011435	3" Square Tension Band 13ga. X 7/8"	0.38	50
011437	4" Square Tension Band 13ga. X 7/8"	0.48	25
011439	6" Square Tension Band 13ga. X 7/8"	0.65	25

## SQUARE BRACE BAND 13 GA. X 7/8"

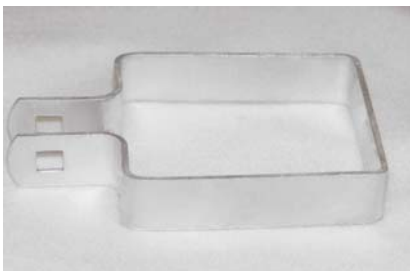

Galvanized bands made from 13 gauge x 7/8" steel for square tubing.

Part #	Description	Weight	Pc. Per Pkg.
012433	2" Square Brace Band 13ga. X 7/8"	0.30	50
012434	2 1/2" Square Brace Band 13ga. X 7/8"	0.36	50
012435	3" Square Brace Band 13ga. X 7/8"	0.41	50
012437	4" Square Brace Band 13ga. X 7/8"	0.50	25
012439	6" Square Brace Band 13ga. X 7/8"	0.65	25

## SQUARE LINE RAIL CLAMP



11 gauge Square Line Rail Clamps are a two-piece clamp designed for 180° horizontal square rail connections to a square line post. Carriage bolt and nut sold separately.

Part #	Description	Weight	Pr. Per Pkg.
013376	2 1/2" X 1 1/4" Square Line Rail Clamp	0.59	50
013377	2 1/2" X 1 1/2" Square Line Rail Clamp	0.70	50

## SQUARE GATE HINGE

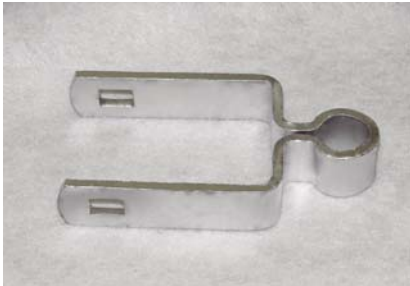

Female hinge designed to fit on square tubing. Uses 3/8" bolts not included. 9 gauge material.

Part #	Description	Weight	Pc. Per Pkg.
014382	1 1/2" X 1/2" -1" Square Gate Hinge	0.26	50
014391	1" X 5/8" -1" Square Gate Hinge	0.25	50
014391S	1 1/4" X 5/8" -1" Square Gate Hinge	0.28	50
014392	1 1/2" X 5/8" -1" Square Gate Hinge	0.30	50
014393	2" X 5/8" -1" Square Gate Hinge	0.50	50

## WELD-ON POST HINGE & SQUARE POST HINGE

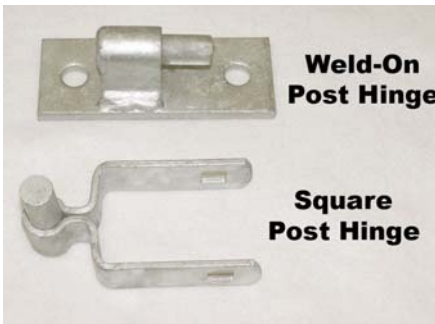

**Weld-On Post Hinge** - Galvanized steel bracket designed to be welded or bolted on any flat surface. This is the male hinge in 5/8" size.

**Square Post Hinge** - Galvanized male hinges designed to bolt on square tubing. These have 5/8" pins, using 3/8" bolts for attachment; not included.

Part #	Description	Weight	Pc. Per Pkg.
014672	5/8" Weld-On Post Hinge	0.83	50
014681	1" X 5/8" Square Post Hinge	0.40	50
014682	1 1/2" X 5/8" Square Post Hinge	0.50	50
014683	2" X 5/8" Square Post Hinge	0.65	50
014684	2 1/2" X 5/8" Square Post Hinge	0.95	50
014685	3" X 5/8" Square Post Hinge	1.05	25
014687	4" X 5/8" Square Post Hinge	1.30	25

## PRESSED STEEL SQUARE COLLAR

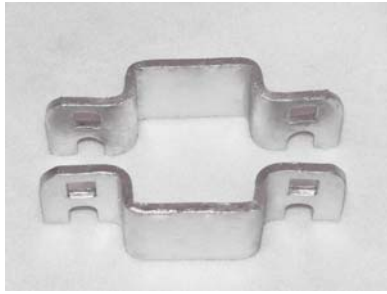

8 gauge x 1 1/4" wide galvanized collars for square tubing. Designed to hang square forks on square tubing.

Part #	Description	Weight	Pr. Per Pkg.
016021	1" Square PS Collar	0.35	50
016021S	1 1/4" Square PS Collar	0.43	50
016022	1 1/2" Square PS Collar	0.45	50
016023	2" Square PS Collar	0.60	50

## PRESSED STEEL SQUARE FORK

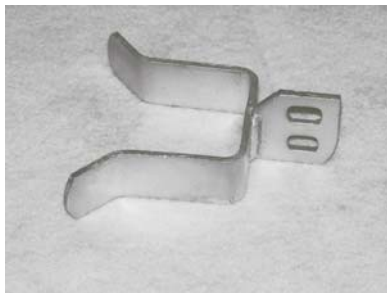

Galvanized steel square forks to be used in conjunction with square collars above.

Part #	Description	Weight	Pc. Per Pkg.
016221	1" Square PS Fork	0.30	50
016222	1 1/2" Square PS Fork	0.38	50
016223	2" Square PS Fork	0.43	50
016224	2 1/2" Square PS Fork	0.51	50
016225	3" Square PS Fork	0.75	50
016227	4" Square PS Fork	0.95	25

## Welded Wire Clamps

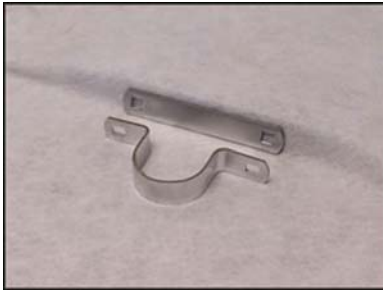

Welded Wire Clamps are designed to attach welded wire panels to the post for support of your panels. Available in 1 5/8", 1 7/8", 2 3/8", 2 7/8" and 4" sizes. Material is 11 gauge x 1.

Part #	Description	Weight	Pr. Per Pkg.
018612	1 5/8" Welded Wire Clamp	0.44	100
018613	1 7/8" Welded Wire Clamp	0.48	100
018614	2 3/8" Welded Wire Clamp	0.53	50
018615	2 7/8" Welded Wire Clamp	0.59	50
018617	4" Welded Wire Clamp	0.73	50

## 3 – D STARS



3 – D Stars are used in many decorative applications. We offer a single or double-sided version.

Part #	Description	Weight	Pc. Per Pkg.
018903	18" 3 – D Star	2.25	LOOSE
018904	24" 3 – D Star	3.75	LOOSE
018913	18" Double Sided 3 – D Star	4.50	LOOSE
018914	24" Double Sided 3 – D Star	7.50	LOOSE

# POWDER COATED FITTINGS:

## BLACK POWDER COATED FITTINGS:

### BLACK POWDER COATED TENSION BAND



14 gauge x 3/4" offset strip of metal shaped to fit around terminal posts. These come with 5/16" x 1 1/2" carriage bolt and nut.

Part #	Description	Weight	Pc. Per Pkg.
081104BK	2 3/8" Black Powder Coated Tension Band w/bolt	0.24	100

### BLACK POWDER COATED BRACE BAND



12 gauge x 3/4" strip of metal shaped to fit around post to attach rail ends to that post. Can also be used to attach tighteners, brace rail ends or barbwire to post. A 5/16" x 1 1/2" carriage bolt and nut is included.

Part #	Description	Weight	Pc. Per Pkg.
082204BK	2 3/8" Black Powder Coated Brace Band w/bolt	0.27	100

### BLACK POWDER COATED END RAIL CLAMP



End rail clamps are a two-piece clamp designed for horizontal connections for rails. Also called gate brace clamps.

Part #	Description	Weight	Pr. Per Pkg.
083350BK	1 3/8" X 1 3/8" Black Powder Coated End Rail Clamp	0.32	100

## BLACK POWDER COATED FEMALE GATE HINGE



Female fitting that attaches to gate frame and functions with the post hinge. Comes with 3/8" bolt and nut.

Part #	Description	Weight	Pc. Per Pkg.
084321BK	1 3/8" X 5/8" Blk Pdr Ctd Female Gate Hinge w/ Bolt	0.47	100

## BLACK POWDER COATED POST HINGE



Male fitting that attaches to gatepost, and when used with female gate hinge, permit the gate to swing. Comes with bolt and nut.

Part #	Description	Weight	Pc. Per Pkg.
084404BK	2 3/8" X 5/8" Black Powder Coated Post Hinge w/Bolt	0.83	50

## BLACK POWDER COATED SPECIAL GATE CLIP



Gate clip designed to be installed with special gate clip tool, to attach fence fabric to gate frame. Used on sides of gate frame in conjunction with tension bars.

Part #	Description	Weight	Pc. Per Pkg.
085351BK	1 3/8" X 5/8" Black Powder Coated Special Gate Clip	0.14	250

## BLACK POWDER COATED GATE SCROLL

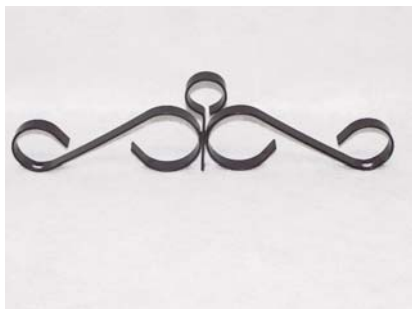

Gate scrolls are decorative fittings that attach to top rails of gates.

Part #	Description	Weight	Pc. Per Pkg.
085653BK	18" 3 pc. Black Powder Coated Gate Scroll	1.22	10

## BLACK POWDER COATED GATE COLLAR



Collars are attached to fork and post to form gate latch assembly.

Part #	Description	Weight	Pr. Per Pkg.
086001BK	1 3/8" Black Powder Coated Gate Collar	0.44	100

## BLACK POWDER COATED GATE FORK



Pressed steel fork used in conjunction with gate collars to make up latch assembly.

Part #	Description	Weight	Pc. Per Pkg.
086101BK	1 3/8" Black Powder Coated Gate Fork	0.31	50
086104BK	2 3/8" Black Powder Coated Gate Fork	0.45	50

## BLACK ALUMINUM FABRIC TIES



Fabric ties designed to attach chain link to rail tubing. Aluminum ties are available in 9ga with different lengths. Black vinyl coated.

Part #	Description	Weight	Pc. Per Pkg.
088033BK	Aluminum Fabric Ties 9 ga. x 6 1/2	0.38	3700
088034BK	Aluminum Fabric Ties 9 ga. x 8 1/4	0.42	3100

## BLACK POWDER COATED ALUMINUM DOME CAP



Black powder coated aluminum caps for sealing pipes to prevent corrosion.

Part #	Description	Weight	Pc. Per Pkg.
089301BK	1 3/8" Black Powder Coated Aluminum Dome Cap	0.05	200
089302BK	1 5/8" Black Powder Coated Aluminum Dome Cap	0.06	100
089303BK	1 7/8" Black Powder Coated Aluminum Dome Cap	0.10	100
089304BK	2 3/8" Black Powder Coated Aluminum Dome Cap	0.10	50
089305BK	2 7/8" Black Powder Coated Aluminum Dome Cap	0.15	30

## BLACK POWDER COATED ALUMINUM LINE TOP



Loop caps for line posts designed to attach top rails. Also prevents moisture from attacking inner post.

Part #	Description	Weight	Pc. Per Pkg.
089331BK	1 5/8" X 1 3/8" Black Powder Coated Alum. Line Top	0.12	50
089333BK	1 7/8" X 1 3/8" Black Powder Coated Alum. Line Top	0.17	25
089343BK	1 7/8" X 1 5/8" Black Powder Coated Alum. Line Top	0.20	25
089344BK	2 3/8" X 1 5/8" Black Powder Coated Alum. Line Top	0.25	20

## BLACK POWDER COATED ALUMINUM RAIL END



Aluminum fitting to stop rail ends. Usually attached with brace bands.

Part #	Description	Weight	Pc. Per Pkg.
089351BK	1 3/8" Black Powder Coated Aluminum Rail End	0.14	100
089352BK	1 5/8" Black Powder Coated Aluminum Rail End	0.16	50

## BLACK POWDER COATED ALUMINUM HEX ELL



Aluminum corners designed to make 90° corners for gates.

Part #	Description	Weight	Pc. Per Pkg.
089361BK	1 3/8" Black Powder Coated Aluminum Hex Ell	0.38	50

# GREEN POWDER COATED FITTINGS:

## GREEN POWDER COATED TENSION BANDS



14 gauge x 3/4" offset strip of metal shaped to fit around terminal posts. These come with 5/16" x 1 1/2" carriage bolt and nut.

Part #	Description	Weight	Pc. Per Pkg.
091104GN	2 3/8" Green Powder Coated Tension Band w/Bolt	0.24	100

## GREEN POWDER COATED BRACE BAND



12 gauge x 3/4" strip of metal shaped to fit around post to attach rail ends to that post. Can also be used to attach tighteners, brace rail ends or barbwire to post. A 5/16" x 1 1/2" carriage bolt and nut is included.

Part #	Description	Weight	Pc. Per Pkg.
092204GN	2 3/8" Green Powder Coated Brace Band w/Bolt	0.27	100

## GREEN POWDER COATED END RAIL CLAMP



End rail clamps are a two-piece clamp designed for horizontal connections for rails. Also called gate brace clamps.

Part #	Description	Weight	Pr. Per Pkg.
093350GN	1 3/8" X 1 3/8" Green Powder Coated End Rail Clamp	0.32	100

## GREEN POWDER COATED FEMALE GATE HINGE



Female fitting that attaches to gate frame and functions with the post hinge. Comes with 3/8" bolt and nut.

Part #	Description	Weight	Pc. Per Pkg.
094321GN	1 3/8" X 5/8" Grn Pdr Ctd Female Gate Hinge w/ Bolt	0.47	100

## GREEN POWDER COATED POST HINGE



Male fitting that attaches to gatepost, and when used with female gate hinge, permit the gate to swing. Comes with bolt and nut.

Part #	Description	Weight	Pc. Per Pkg.
094404GN	2 3/8" X 5/8" Green Powder Coated Post Hinge w/Bolt	0.83	50

## GREEN POWDER COATED SPECIAL GATE CLIP



Gate clip designed to be installed with special gate clip tool, to attach fence fabric to gate frame. Used on sides of gate frame in conjunction with tension bars.

Part #	Description	Weight	Pc. Per Pkg.
095351GN	1 3/8" X 5/8" Green Powder Coated Special Gate Clip	0.14	250

## GREEN POWDER COATED GATE SCROLL

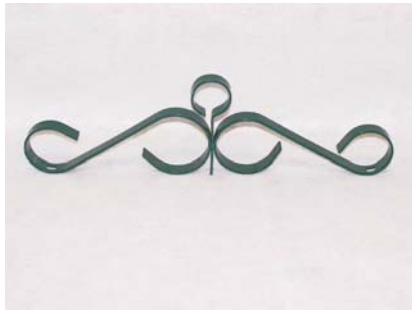

Gate scrolls are decorative fittings that attach to top rails of gates.

Part #	Description	Weight	Pc. Per Pkg.
095653GN	18" 3 pc. Green Powder Coated Gate Scroll	1.22	10

## GREEN POWDER COATED GATE COLLAR



Collars are attached to fork and post to form gate latch assembly.

Part #	Description	Weight	Pr. Per Pkg.
096001GN	1 3/8" Green Powder Coated Gate Collar	0.44	100

## GREEN POWDER COATED GATE FORK



Pressed steel fork used in conjunction with gate collars to make up latch assembly.

Part #	Description	Weight	Pc. Per Pkg.
096101GN	1 3/8" Green Powder Coated Gate Fork	0.31	50
096104GN	2 3/8" Green Powder Coated Gate Fork	0.45	50

## GREEN ALUMINUM FABRIC TIES

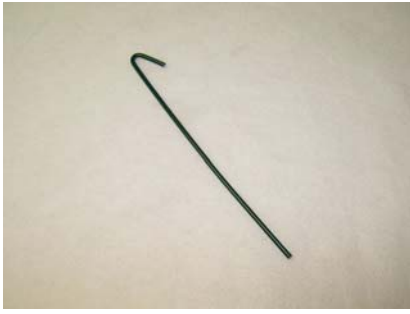

Fabric ties designed to attach chain link to rail tubing. Aluminum ties are available in 9ga. with different lengths. Black vinyl coated.

Part #	Description	Weight	Pc. Per Pkg.
098033GN	Aluminum Fabric Ties 9ga. x 6 ½	0.38	3700
098034GN	Aluminum Fabric Ties 9ga. x 8 ½	0.42	3100

## GREEN POWDER COATED ALUMINUM DOME CAP



Cast aluminum caps for sealing pipes to prevent corrosion.

Part #	Description	Weight	Pc. Per Pkg.
099304GN	2 3/8" Green Powder Coated Aluminum Dome Cap	0.10	50

## GREEN POWDER COATED ALUMINUM LINE TOP



Loop caps for line post designed to attach top rails. Also prevents moisture from attacking inner post.

Part #	Description	Weight	Pc. Per Pkg.
099331GN	1 5/8" X 1 3/8" Green Powder Coated Alum. Line Top	0.12	50

## GREEN POWDER COATED ALUMINUM RAIL END



Aluminum fitting to stop rail ends. Usually attached with brace bands.

Part #	Description	Weight	Pc. Per Pkg.
099351GN	1 3/8" Green Powder Coated Aluminum Rail End	0.14	100

## GREEN POWDER COATED ALUMINUM HEX ELL



Aluminum corners designed to make 90° corners for gates.

Part #	Description	Weight	Pc. Per Pkg.
099361GN	1 3/8" Green Powder Coated Aluminum Hex Ell	0.38	50